

POURING PERFORMANCE SINCE 1983

For over 30 years, **Energy Suspension** continues to be the World leader in performance polyurethane suspension technology. Dedication to manufacturing and developing superior products has established **Energy Suspension** as the most asked-for name in performance polyurethane components today. Having been awarded 10 U.S. Patents proves our innovative designs have set untouchable industry standards as polyurethane continues to amaze the people who work with it. The complex and diverse nature of **Energy's** proprietary **Hyper-Flex®** material requires constant attention to developing the optimum polyurethane formulas. This devotion has produced the quality components that our customers continue to demand. Providing problem-solving solutions with applications for the most popular vehicles, paired with our Limited warranty and superb customer support, **Energy Suspension** is your first quality choice in performance polyurethane suspension components.



RESEARCH & DEVELOPMENT



ENGINEERING



INNOVATION – 10 U.S. PATENTED PRODUCTS



MANUFACTURING

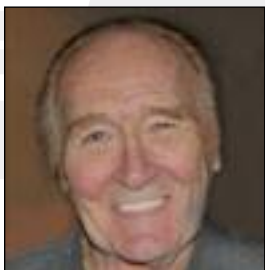

We are proud to offer our customers the finest polyurethane suspension components available in the marketplace today. Our policy of manufacturing in-house from the initial R & D stages, to chemical formulation, molding and final packaging allows us to control every aspect of the manufacturing process. This ability produces a genuine **American-Made** product and gives our customers absolute confidence in the **Energy Suspension** name. We pledge to continue to be Number One in quality, coverage and customer service because our customers are Number One with us. This is our commitment to excellence. So, from myself and the team at **Energy Suspension**, we thank you for your support.

Sincerely,

Don Bunker
President



Table Of Contents

Heading Page Number

Motor & Transmission Mounts For G.M. & Ford14 thru 20
Hyper-Flex® System Master Sets21 thru 26

Universal Applications and Accessories

Bump Stops10
Coil Spring Damper Inserts12
Coil Spring Isolators13
Custom Fabrication Products11 & 12
Creeper Wheels75
Four Bar Link Bushings11
Jack Strap12
Lubricant12
Shock Bushings9
Shock Reservoir Isolators9
Sway Bar Bushing Sets7
Sway Bar End Link Sets & Bushings8 & 9
Tie Down Straps75
Tie Rod End & Ball Joint Dust Boots13
Universal Bushings – Isolation/Body Mounts, Link Arms ..11 & 12

Passenger Car Applications.....26 thru 55

Acura27
BMW28
Buick28
Cadillac29
Chevrolet29 thru 35
Camaro30 & 31
Chrysler36 thru 39
Corvette32 & 33
DatsunSee Nissan
Dodge36 thru 39
Eagle38
Ferrari39
Ford40 thru 43
Honda43 thru 45
Infiniti45
Lincoln46
Mazda46 & 47
Mercury46
MG48
Mitsubishi47
Nissan/Datsun48 & 49
Oldsmobile50
Plymouth36 thru 39
Pontiac50 thru 52
Scion52
Subaru53
Toyota53
Volkswagen54 & 55

Truck, SUV & Van Applications 56 thru 72

Cadillac56 & 58
Chevrolet56 thru 60
DatsunSee Nissan
Dodge & Plymouth61 & 62
Ford63 thru 67
Hummer58
Isuzu68
Jeep68 thru 70
Lexus70
Lincoln63-67
Mazda70
Mitsubishi71
Nissan/Datsun71
Scout II71
Suzuki71
Toyota71 thru 73

Apparel and Promotional Products74-75

Explanation Of Set Numbers

3 . 3 1 0 1 R

Manufacturer	General Description	Set No.	Color
1-Suzuki	1-Motor & Transmission Mounts	101	G-Black
2-Jeep	2-Spring Bushings	102	R-Red
3-General Motors	3-Control Arm Bushings	104	
4-Ford Co.	4-Body Mounts	ETC.	
5-Chrysler Products	5-Stabilizer Bar Bushings		
5-Mitsubishi	6-Spring Isolators & Strut Stops		
6-Scout/International	7-Strut & Tracking Arms		
7-Nissan/Datsun	8-Shock Bushings & End Links		
8-Scion	9-Universal Application		
8-Toyota	10-Rack & Pinion		
9-Universal Appl.	11-Lubricant		
10-MG	12-Apparel: Jackets, Shirts, Caps		
11-Mazda	13-Tie Rod & Ball Joint Boots		
12-BMW	16-Steering Couplers		
13-Ferrari	18-Hyper-Flex® System Master Sets		
14-Isuzu			
15-Volkswagen			
16-Acura			
16-Honda			
18-Saturn			
19-Subaru			

Available Colors:



Red (R)



Black (G)

NOTE: For product color- add R (for red) or G (for black) after each part number.

Limited 2-Year Warranty

Energy Suspension warrants its products against defects in workmanship or material for 24 months, when used on passenger cars or light trucks. Products that have been abused, altered, or incorrectly installed are not covered. Product finish and normal wear are not covered. **Energy Suspension** will replace defective products or component parts, if inspection by factory personnel determines the part to be defective. Warranty replacement covers only the product. Labor claims, time loss, or freight charges will not be honored.

NOTE: Colors, materials, components, specifications, and prices are subject to change without prior notice. We reserve the right to refer inquires to established **Energy Suspension** distributors.



PRINTING ERRORS: Every effort has been made to avoid printing errors in our catalog. We disclaim any responsibility for any application or specification errors.



HYPER-FLEX.

Why Hyper-Flex® Polyurethane?

Soft or worn-out O.E.M. rubber bushings and mounts will cause poor handling and alignment, excessive body roll and dangerous drivetrain movement. Energy Suspension's Hyper-Flex® material is the result of years of experience working with and formulating polyurethane materials perfected to outlast and outperform rubber. Careful selection of material firmness or durometer is used for each specific application on the vehicle's suspension and chassis to ensure improved vehicle control without compromising ride quality.

We call it: **Hyperformance**

The most important reasons for using Energy Suspension's Hyper-Flex® components:

- PERFORMANCE
- DURABILITY
- VALUE

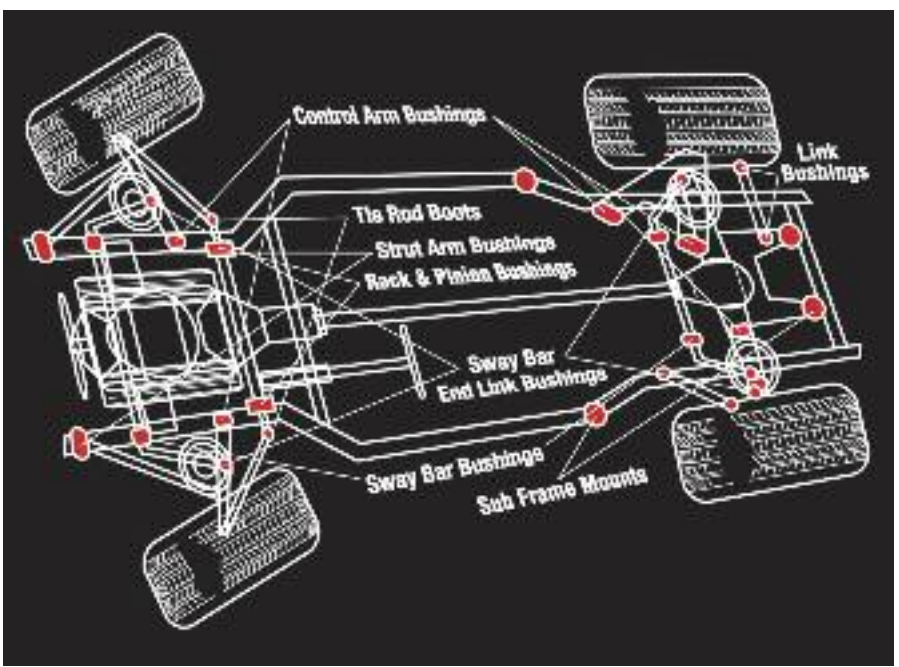

Energy's Hyper-Flex® is superior performance polyurethane which has proven itself under the most demanding conditions on the race track, off-road and street performance driving, Hyper-Flex® components do not wear or deteriorate from exposure to undercar chemicals such as oils and coolants and withstand atmospheric conditions like UV exposure and pollutants. Impervious to these elements, Energy's Hyper-Flex® components are a great value. Not only will it outlast rubber 5 to 1 but are a cost effective performance improvement for your car or truck. Whether domestic or import, front, rear or 4WD, old or new, your vehicle will achieve that level of performance that has made Energy Suspension the most asked-for name in performance polyurethane components.



PRODUCT INFO



Sway Bar (Stabilizer Bar) Bushings & End Links

Will make your vehicle's sway bar system more effective with proper durometer (firmness) polyurethane to greatly improve contact between the sway bar and the vehicles chassis. An easy and cost-effective suspension upgrade, they offer the greatest improvement in performance handling and outlast rubber. Greaseable bushings feature zerk type fittings, allowing for periodic greasing. Channel-designed bushings allow for the lube to migrate for better coverage.



Control Arm Bushings

Replace worn or soft bushings for better alignment tracking while cornering, stopping and hard launching. Recommended for lowered or raised vehicles when height is altered or greater suspension load is required. All control arm bushings are full floating and nonbinding for better caster and camber stability during hard driving. The rear control arm bushings control wheel hop and increasing cornering control. Many sets come complete with zinc plated outer metal shells to prevent corrosion.



Note: For product color add R for red or G for black after each part number.



Leaf Spring Bushings

Be in control going through turns, during standing start accelerations, braking, and over bumps and berms. Allows the leaf spring system to function more effectively. Combined with heavy duty/performance leaf springs, they deliver maximum benefit. These bushings also improve lighter-duty leaf spring systems, adding a higher degree of performance and durability. You'll feel the difference in positive handling and control.



Motor Mounts

Engine rebuild or swap? Don't forget Hyper-Flex® performance polyurethane motor mounts offer the best of both worlds: smooth running for street performance driving yet durable for the track. As strong as solid metal mounts yet dampen motor vibration and noise with tough, compliant polyurethane. Early Chevy styles have a patented "safety interlock" design while the Clam Shell versions are re-engineered to deliver better performance, under all conditions!



Motor Mount Inserts

For front wheel drive vehicles. These polyurethane inserts add support and stability under high performance conditions to the existing O.E.M. motor mount system. Restore worn mounts to reduce wheel hop and torque-induced movement that can damage components!



Transmission Mounts

Professionals know Energy's transmission mounts have set the industry standard, making them the most popular component in our company's history. Exceeding expectations on the street, track or off-road, several applications utilize Energy's Hyper-Flex® polyurethane and patented safety interlock design.



Body & Cab Mounts

Restore ride height as well as gain durability! Original rubber mounts do wear out, distort, and fail so badly they often fall off. Aluminum mounts are too harsh, causing other parts to break. Energy's specially formulated polyurethane body and cab mounts provide a smooth ride, tough enough for the most demanding road or track. Most are molded with steel rings for added durability and some include zinc coated hardware.



Bump Stops & Strut Stops

Formulated for control arms, traction bars, axles and leaf springs. Guaranteed to last longer and operate more efficiently than O.E.M. rubber stops. Protects shocks and struts from bottoming out preventing expensive damage. O.E.M. replacement style applications, smaller, bullet-shaped snubber for control arms and larger competition race styles have a reinforced metal plate welded to the mount for track and off road use.

Note: For product color add R for red or G for black after each part number.





Strut Rod Bushings

Adding plus-size wheels and tires cause extra loads on O.E.M. rubber strut rod bushings resulting in irregular alignment and premature failure of the lower control arm bushings. While braking, the wheels and lower control arm assembly can roll under causing loss of steering and control. Energy's polyurethane bushings help reduce common wheel "roll-under" and greatly reduce wheel hop on FWD vehicles.



Shock Bushings

Will give any shock maximum efficiency while extending its life. Rubber bushings will crack and wear out while polyurethane shock bushings and grommets last forever and add to the overall performance of every shock.



Polyurethane Coil Lift Isolator Sets

Popular Coil Lift Isolators for trucks and Jeeps now available in Hyper-Flex® performance polyurethane. These offer a simple and inexpensive chassis lift from .75" to 2", depending on the application.



Tie Rod & Ball Joint Boots

Don't buy an entire tie rod assembly when only the boot needs replacing! Replace worn or ruined existing rubber boots with durable polyurethane to seal out contaminants and prevent loss of lubricants. Lasts longer, seals stronger and looks better.

HYPER-FLEX SYSTEM®



Master Sets

Do it right by getting the combined performance of all component sets and save money. Includes all you need in one convenient package.



SWAY BAR BUSHING SETS

Dollar-for-dollar Energy Suspension performance polyurethane sway bar bushings and end links offer the greatest improvement in performance among all the products Energy offers. They make a vehicle's sway bar system much more effective—like adding a larger, higher performance sway bar! Economy, increased efficiency, and easy installation are just some of the reasons these products are so popular. Made of Hyper-Flex® polyurethane that outlasts and outperforms rubber bushings.

NOTE: Properly Measure your sway bar diameter AND refer to the specific vehicle page for the proper OEM/stock style sway bar bushing sets BEFORE choosing sway bar bushing sets from this page.

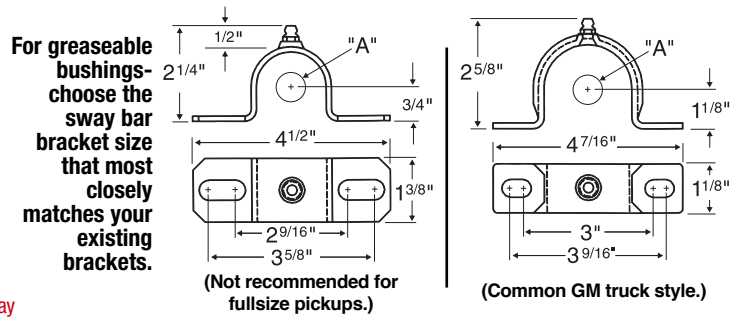

Greaseable Type

Complete with zerk fittings and utilizing a unique channel design, allowing grease to flow to all inner bushing surfaces. This innovative design will virtually eliminate any possible squeaking. Use the dimensional drawings at right to determine the proper size for your application. The bolt slot dimensions were designed for 10mm or 3/8" diameter mounting bolts.



Bar Diameter "A"	Greaseable Set #	Greaseable Set #
7/16" / 11mm	9.5151	
1/2" / 13mm	9.5152	
9/16" / 14mm	9.5153	
5/8" / 16mm	9.5154	
11/16" / 17.5mm	9.5155	
3/4" / 19mm	9.5156	
13/16" / 20.5mm	9.5157	
7/8" / 22mm	9.5158	
23mm	9.5159	
15/16" / 24mm	9.5160	
1" / 25mm	9.5161	
1 1/16" / 27mm	9.5162	9.5169
28mm	9.5163	
1 1/8" / 28.5mm	9.5164	9.5170
1 3/16" / 30mm		9.5171
1 1/4" / 31.5mm	9.5165	9.5172
32mm	9.5166	
1 5/16" / 33mm	9.5167	
1 3/8" / 35mm	9.5168	9.5173
1 7/16"		9.5175

Non-Greaseable Type

These precision Hyper-Flex® bushings, with matching heavy gauge brackets, economically deliver maximum performance to a vehicle's sway bar system.

Use the dimensional drawings at right to determine the proper size for your application. The bolt slot dimensions were designed for 10mm or 3/8" diameter mounting bolts.

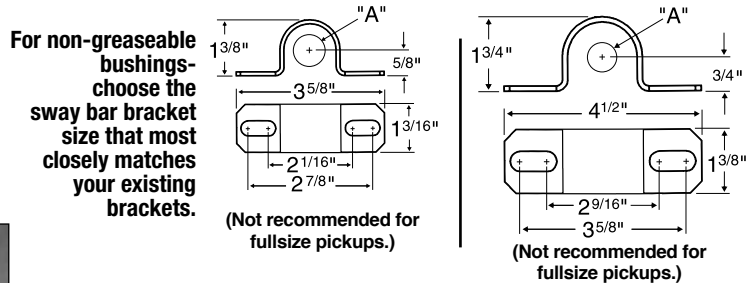
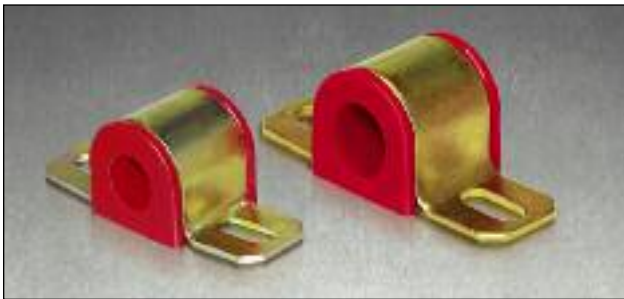

Bar Diameter "A"	Non-Greaseable Set #	Non-Greaseable Set #
7/16" / 11mm		9.5101
1/2" / 13mm		9.5102
9/16" / 14mm		9.5103
5/8" / 16mm	9.5120	9.5104
17mm	9.5121	
11/16" / 17.5mm		9.5105
18mm	9.5122	
3/4" / 19mm	9.5123	9.5106
20mm	9.5124	
13/16" / 20.5mm		9.5107
21mm	9.5125	
7/8" / 22mm	9.5126	9.5108
23mm	9.5127	9.5115
15/16" / 24mm	9.5128	9.5109
1" / 25mm	9.5129	9.5110
1 1/16" / 27mm		9.5111
28mm		9.5130
1 1/8" / 28.5mm		9.5112
1 1/4" / 31.5mm		9.5113
32mm		9.5116
1 5/16" / 33mm		9.5114

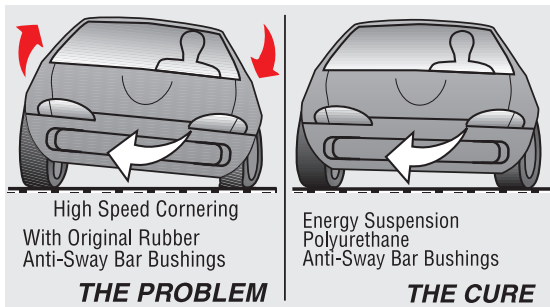

Note: For product color add R for red or G for black after each part number.



UNIVERSAL

SWAY BAR END LINKS

They're economical, increase efficiency and are easy to install. Use with our Hyper-Flex® polyurethane sway bar bushings to get maximum performance benefits. Combine both for the same effect as buying a larger sway bar. Together they offer a dramatic handling improvement over any stock or replacement rubber bushing set.

They also last much longer than O.E.M. rubber end links, not crushing out of shape after just a short time. Superior performance and greater longevity!

NOTE: Please refer to the specific vehicle page for the proper O.E.M./stock style sway bar end link sets *BEFORE* choosing end link sets from this page.



Complete Heavy Duty End Link Sets

Complete end link set includes bushings, zinc plated 3/8" grade 5 bolts, "nylock" nuts and heavy gauge washers. Use chart only when vehicles are not listed in the application section.

TO FIT: Vehicle must be on level ground (not jacked up) with wheels supporting it. Make sure stabilizer bar end eyelet (B) is parallel with control arm (C). Many times they are not. You may be required to use a slightly longer or shorter sleeve length than the original. Measure sleeve length (A) and compare to the chart to find the correct set.

ADJUST-A-LINK Adjustable Length End Links

These end link sets include two different height bushings which enable you to mix and match to obtain the optimal length. Each set number offers 1/2" of adjustability in 1/4" increments. They will accommodate lengths of 2 3/4" to 6 3/8" with only 6 part numbers. That's 4 less vs. fixed length links and no gaps in "A" length coverage! Includes 3/8" zinc plated rod with hardware.

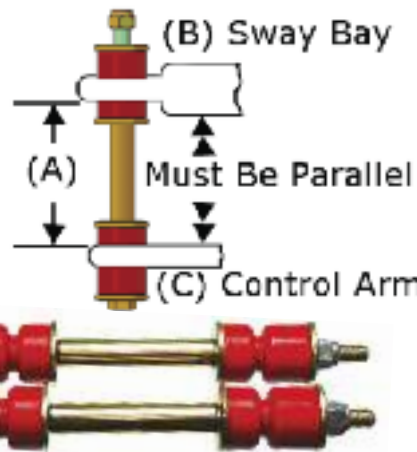

"A" Length	Set Number
2 3/4"-3 1/4" 70mm-83mm	9.8162
3 3/8"-3 7/8" 86mm-99mm	9.8163
4"-4 1/2" 102mm-115mm	9.8164
4 5/8"-5 1/8" 117mm-130mm	9.8165
5 1/4"-5 3/4" 133mm-146mm	9.8166
5 7/8"-6 3/8" 149mm-162mm	9.8167

NOTE: Adjust-A-Link and fixed length end links use different measuring points for "A" length

Fixed Length End Links

Complete end link set includes bushings, zinc plated 3/8" grade 5 bolts, "nylock" nuts and heavy gauge washers.

"A" Length	Fixed Length Set Number	Adjust-A-Link X-Reference
1"	9.8122	9.8162
1 5/8"	9.8120	9.8163
2"	9.8123	9.8163
2 3/8"	9.8125	9.8164
2 5/8"	9.8117	9.8164
2 7/8"	9.8118	9.8165
3 3/8"	9.8119	9.8165
3 9/16"	9.8124	9.8166
4 1/4"	9.8149	9.8167
4 1/2"	9.8121	9.8167
6"	9.8175	
5 5/16"	9.8176	

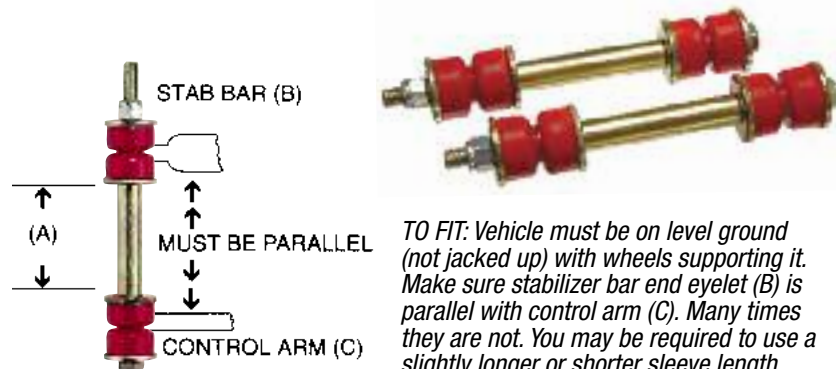

TO FIT: Vehicle must be on level ground (not jacked up) with wheels supporting it. Make sure stabilizer bar end eyelet (B) is parallel with control arm (C). Many times they are not. You may be required to use a slightly longer or shorter sleeve length than the original. Measure sleeve length.

PIVOT STYLE END LINK SETS

Our pivot style end link will outlast and outperform their OEM counterpart. Features an innovative polyurethane socket encasing a metal ball stud. All are armed with our Hyper-Flex® polyurethane, rigid 3/4" steel shaft, extreme duty black coating and 3/8"-16 bolt ends.

- 4 different sizes of 1" increments.
- 1" of additional adjustability
- Match to OE lengths or modified suspensions
- 2 end links per set number

"A" Range	Set Number
3 3/4"-4 3/4"	9.8169
4 3/4"-5 3/4"	9.8170
5 3/4"-6 3/4"	9.8171
6 3/4"-7 3/4"	9.8172
Replacement bushing set (4)	9.8173



Note: For product color add R for red or G for black after each part number.



END LINK BUSHING SETS



9.8105
I.D.— $3/8$ " , Nipple O.D.— $11/16$ " ,
O.D.— $11/8$ " , O.A.L.— $3/4$ "
Incl. 8 grommets, 8 washers



9.8106
I.D.— $3/8$ " , Nipple O.D.— $5/8$ " ,
O.D.— 1 " , O.A.L.— $11/16$ "
For cars & mini trucks. 8 per set.



9.8103
I.D.— $7/16$ " , Nipple O.D.— $7/8$ " ,
O.D.— $11/4$ " , O.A.L.— $3/4$ "
Full size truck style. 4 per set.

SHOCK RESERVOIR ISOLATORS

Energy Suspension shock reservoir isolators are used to mount external shock reservoirs to the shock tube or to the vehicle's roll cage in extreme off road applications. Available in several diameter combinations, these isolators incorporate hose clamp mounting channels on the sides. Sold in sets of two.

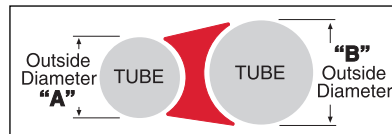

9.9160



9.9163



9.9164

SET #	"A"	"B"
9.9160	2.50"	2.50"
9.9163	1.50"	3.00"
9.9164	1.50"	2.00"

SHOCK BUSHINGS

Energy Suspension Hyper-Flex® performance polyurethane shock bushings give any shock maximum efficiency while extending its life. They last forever and add to the performance of every shock, giving instant response and control to the suspension.

2 per set 9.8116	2 per set 9.8107	2 per set 9.8111	2 per set 9.8109	4 per set 9.8113	4 per set 9.8101	4 per set 9.8126
Fits standard straight eye $5/8$ " I.D., $11/16$ " O.D., $17/16$ " long.	Fits standard hour-glass shaped eye $5/8$ " I.D., 1 " min./ $11/8$ " max. O.D., $17/16$ " long.	Fits Chrysler style straight eye $3/4$ " I.D., $11/4$ " O.D., $15/8$ " long.	Fits large race hour-glass shape $3/4$ " I.D., $11/4$ " min./ $13/8$ " max. O.D., $15/8$ " long.	Half bushings for hourglass style. $5/8$ " I.D., 1 " min./ $11/8$ " max. O.D., $11/16$ " long.	Fits shock tower $7/8$ " nipples. $3/8$ " I.D., $11/4$ " O.D., $5/8$ " thick.	Fits shock tower $5/8$ " nipples. $3/8$ " I.D., $11/4$ " O.D., $5/8$ " thick.
9.8140	9.8108	9.8112	9.8110	9.8142	9.8145	
Fits standard straight eye $3/4$ " I.D., $11/16$ " O.D., $19/16$ " long.	Fits standard hour-glass shaped eye $3/4$ " I.D., 1 " min./ $11/8$ " max. O.D., $17/16$ " long.	Fits Chrysler style straight eye $5/8$ " I.D., $11/4$ " O.D., $15/8$ " long.	Fits large hourglass shape $11/16$ " I.D., $11/4$ " min./ $19/16$ " max. O.D., $15/8$ " long.	Half bushing style for large hourglass. $5/8$ " I.D., $13/16$ " min./ $17/16$ " max. O.D., $13/16$ " long.	Fits large shock tower $15/16$ " nipples. $9/16$ " I.D., $17/8$ " O.D., $15/16$ " thick.	
9.8141				9.8143		9.8146
Fits standard straight eye $5/8$ " I.D., $11/8$ " O.D., $11/4$ " long.				Half bushing style for large hourglass. $3/4$ " I.D., $11/4$ " min./ $11/2$ " max. O.D., $13/16$ " long.		Fits shock tower $5/8$ " nipples. $3/8$ " I.D., $11/4$ " O.D., $7/8$ " thick.
9.8147						9.8144
Fits half of standard straight eye (half of 9.8116 bushing shown above) $5/8$ " I.D., $11/16$ " O.D., $3/4$ " long. 4 bushings per set.						Fits shock tower $5/8$ " nipples. $3/8$ " I.D., $13/8$ " O.D., $15/16$ " thick.

SHOCK & STRUT BUMP STOPS

These bump stops have been designed to be used on various McPherson strut and shock absorber applications as a limiting device, preventing damage to expensive shocks and struts. Made of Hyper-Flex® performance polyurethane. See dimensions for your application. 2 per set.



4.6103

Fits many Ford cars 1979-01. Front position with $7/8$ " shaft diameter. $17/16$ " tall, $23/16$ " OD x $7/8$ " ID.

7.6104

Fits most 1970-78 Nissan cars with $3/4$ " shaft diameter. $13/4$ " tall, 2 " OD x $3/4$ " ID.

9.6109

Fits many strut style and standard shock absorbers with $11/16$ " dia. shaft. $19/16$ " tall, $11/2$ " OD x $11/16$ " ID.

9.6110

Fits many strut style and standard shock absorbers with $5/8$ " dia. shaft. $13/16$ " tall, $11/2$ " OD x $5/8$ " ID.

9.6111

Fits many strut style and standard shock absorbers with $1/2$ " dia. shaft. $11/4$ " tall, $13/8$ " OD x $1/2$ " ID.

10.6101

Fits many strut style and standard shock absorbers with $5/8$ " diameter shaft. $23/16$ " tall, $21/4$ " OD x $5/8$ " ID.

16.9101

Fits many strut style and standard shock absorbers with 12mm dia. shaft. $19/16$ " tall, 2 " OD x 12mm ID.

16.9102

Fits many strut style and standard shock absorbers with 12mm dia. shaft. 2 " tall, $13/4$ " OD x 12mm ID.



BUMP STOPS

Energy Suspension offers a wide assortment of multi-application bump stops and pads. Only your imagination will limit the many uses which can be found for these products. Molded in studs are 3/8" x 16 coarse thread with nylock nut.



9.9101 All purpose bump stop for control arms, traction bars & leaf springs. Designed to be easily trimmed for custom fit. 2 1/8" tall, 2" dia. 2 per set.



9.9103 Smaller general purpose bullet shaped bump stop, fits many control arms. 1 9/16" tall, 1 1/2" dia. 2 per set.



9.9121 Low profile button head bump stop. 1 1/16" tall x 1 5/8" dia. 2 per set.



9.9132 Ultra low profile button head bump stop. 3/8" tall x 2" dia., 1" long stud. 2 per set.



9.9102 Low profile button head bump stop for limited suspension height applications. 1 1/16" tall, 2" dia. 2 per set.



9.9158 Universal octagon bump stop. This bump stop measures 1 7/8" across from flat side to flat side, 1 1/16" tall, 2" dia. 2 per set.



9.9116 Button head bump stop. 1" tall, 2" dia. 2 per set.



9.9117 Flat head bump stop. 1" tall, 2 15/16" dia. 2 per set.



9.9118 Low profile rectangular bump stop. 7/8" tall x 1 7/8" long x 1 3/8" wide. 2 per set.



9.9119 Pointed and rectangular bump stop. 1 3/8" tall x 2 3/8" long x 2" wide. 2 per set.



9.9136 Square tapered style bump stop. 2" tall x 2" square. 7/8" long stud. 2 per set.



9.9150 G.M. style bump stop. Fits many 1970-99 G.M. cars & trucks. 2" tall x 2 1/4" long x 1 1/16" wide. 1" long stud with a 5/16" dia. locating pin at 1" offset. 2 per set.



9.9154 Single hump early GM style. Lower control arm direct replacement for '64-72 Chevelle, '68-72 Nova and '67-69 Camaro. 1 1/8" wide x 2 1/2" long x 1 11/16" tall. 2 per set.



9.9137 2 bolt style, fits '76-86 Jeep CJ5/7 front & rear positions. 1 7/8" tall x 5" overall length x 1 3/4" wide. Accepts 3/8" dia. bolts with center to center of 4 1/4" max. to 4" min. 2 per set.



8.9102 2 Bolt style. 1 15/16" tall X 3 5/16" long X 3 3/16" wide. Accepts 7/16" bolt with center to center of 4 5/16" max. to 3 5/8" min. 2 per set.



9.9104 Designed with a large reinforced metal plate welded to the mounting plate and molded in. 4 1/2" tall x 4 1/2" long x 2 1/2" wide. 2 per set.

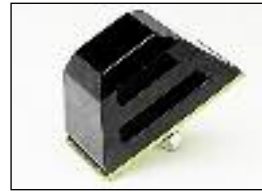

9.9109 Low profile competition style bump stop. 2 1/2" tall x 4 1/2" long x 2 1/2" wide. 2 per set.



9.9151 Round pull thru bump stop. Fits many G.M. vehicles 1970-99. Fits 9/16" hole (1/8" thick) 1 9/16" tall x 1 11/16" dia. 2 per set.



3.9102 G.M. style pull thru bump stop fits many 1978-01 G.M. RWD cars and trucks. 1 1/4" tall x 1 1/2" long x 1 9/16" wide. 2 per set.



3.9103 G.M. style pull thru bump stop. Fits many 1978-88 G.M. RWD cars and trucks. 1 5/8" tall x 1 13/16" long x 1 15/16" wide. 2 per set.



3.9101 G.M. style pull thru bump stop fits many 1978-88 G.M. RWD cars and trucks. 2 5/8" tall x 1 13/16" long x 1 15/16" wide. 2 per set.



9.9165 GM style pull thru bump stop. Fits many GM models. 3" tall x 2 7/16" long x 2 3/8" wide. 2 per set.



2.9101 Jeep front bump stop set fits 1997-06 Jeep Wrangler TJ. Must reuse all metal parts. 2 per set.



9.9135 Stepped style stop. 2 1/2" tall, 2 7/16" dia. Designed to accept 3/8" dia. Allen head bolt. Hardware not included. Easily trimmed for custom fit. 2 per set.



9.9143 Stepped style stop. 3 1/8" tall, 2 7/16" dia. Accepts 3/8" dia. Allen head bolt. Hardware not incl. Trim for a custom fit. 2 per set.



9.9138 Round head bump stop 1 7/8" tall, 2 1/4" dia. Designed to accept 3/8" dia. Allen head bolt. Hardware not included. 2 per set.



9.9149 Button head pad 3/4" tall x 2" dia. To accept 3/8" dia. Button head bolt. Hardware not included. Not to be used as a control arm or axle bump stop. 2 per set.



9.9148 Flat head pad 3/4" tall x 2 3/4" dia. Designed to accept 5/16" dia. button head bolt. Hardware not included. Not to be used as a control arm or axle bump stop. 2 per set.

Note: For product color add R for red or G for black after each part number.

FABRICATION PRODUCTS

Universal Link - Flange Type Bushings

Made from our Hyper-Flex® formula for extreme durability. Suggested uses include control arms, track rods, 4 bar links, push/nerf bars, tire carrier racks, engine/transmission mounts.

Please note the proper preloads are calculated based on the dimensions listed in the chart. A non-preloaded bushing is not recommended. Only use DOM tubing or equivalent with no seam on I.D. of tubing. Each set includes 4 - Bushings and 2 - Sleeves. Outer tube and fastener are not included.

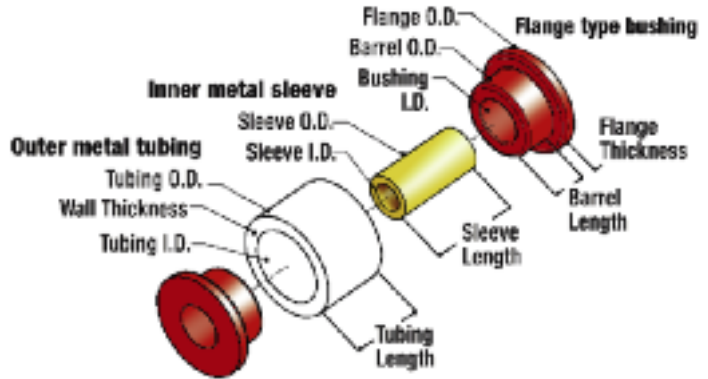

Outer Tube Dimensions			Bushing Dimensions					Inner Sleeve Dimensions			Fastener	
Inner Dia.	Length	Minimum Wall Thickness	Outer Dia. (preload included)	Inner Dia.	Barrel Length	Flange Outer Dia.	Flange Thickness	Outer Dia.	Inner Dia.	Length	Bolt Dia.	Set Number
.857	2.000	0.134	.871	.500	.967	1.163	.156	-----	-----	-----	1/2"	9.9176
1.000	2.500	0.156	1.010	0.495	1.220	1.335	0.240	-----	-----	-----	1/2"	2.2117
1.000	2.500	0.156	1.010	0.563	1.220	1.320	0.214	-----	-----	-----	9/16"	9.9177
1.125	1.062	0.125	1.140	0.750	0.500	1.390	0.187	0.750	0.500	1.400	1/2"	9.9105
1.125	1.037	0.125	1.140	0.750	0.500	1.390	0.187	0.750	0.562	1.375	9/16"	9.9106
1.125	1.480	0.125	1.140	0.812	0.715	1.375	0.139	0.812	0.625	1.750	5/8"	9.9111
1.250	1.312	0.187	1.265	0.750	0.614	1.630	0.219	0.750	0.500	1.750	1/2"	9.9107
1.250	1.312	0.187	1.265	0.750	0.614	1.630	0.219	0.750	0.562	1.750	9/16"	9.9108
1.250	2.550	0.187	1.265	0.750	1.235	1.785	0.235	0.750	0.500	3.085	1/2"	2.2120
1.250	2.250	0.187	1.265	0.875	1.105	1.755	0.240	0.875	0.625	2.750	5/8"	4.2132
1.375	1.650	0.187	1.382	0.875	0.829	1.782	0.285	0.875	0.500	2.250	1/2"	9.9482
1.375	2.350	0.187	1.382	0.750	1.145	1.695	0.325	0.750	0.562	3.000	9/16"	3.2126
1.500	1.960	0.250	1.510	0.750	0.950	1.975	0.207	0.750	0.500	2.375	1/2"	9.9483
1.500	1.960	0.250	1.510	0.750	0.950	1.975	0.207	0.750	0.562	2.375	9/16"	9.9489
1.500	2.520	0.250	1.510	0.750	1.220	1.985	0.250	0.750	0.562	3.000	9/16"	3.2124
1.750	1.350	0.250	1.760	0.875	0.600	2.178	0.250	0.875	0.562	1.875	9/16"	9.9484
1.750	2.520	0.250	1.760	0.750	1.230	2.200	0.250	0.750	0.562	3.000	9/16"	3.2125
1.750	2.550	0.250	1.760	0.872	1.220	2.195	0.187	0.875	0.625	2.930	5/8"	9.9488
2.000	2.075	0.250	2.040	0.875	1.000	2.500	0.220	0.875	0.625	2.530	5/8"	9.9485

Universal Mounts/Isolators

Made of Hyper-Flex® performance polyurethane. For use as isolator mounts on applications such as obsolete rubber body mounts, kit cars, truck beds, tool boxes and many other similar applications. (See diagram for specific parameters.)

Two Complete Mounts Per Set which includes:
4 plated metal washers, 2 plated metal sleeves, 4 bushings



Firm Bushing - 88A Durometer 9.4101

For off road applications, drag vehicles, road racers, extreme use vehicles and various applications which require firmer mounting.

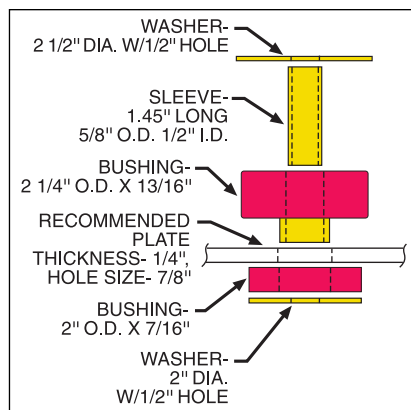

Soft Bushing - 70A Durometer 9.4102

For applications which require a higher degree of isolation: universal transmission and motor mounts. Also can be used for air compressors, tool boxes, generators, independent engines, etc.

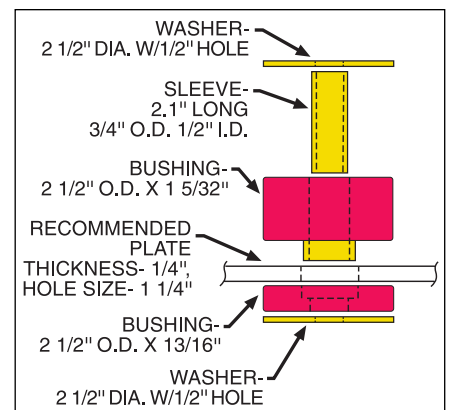

Note: For product color add R for red or G for black after each part number.



FABRICATION PRODUCTS

NEW Polyurethane Pads

These new pads are super strong, chemical resistant and have hundreds of automotive, industrial or home uses. They can be used as mounting pads, spacers...you name it! **Each set contains 8 pads***.



Round				
OD	Hole ID	Height	Hardness	Set Number*
2 9/32	7/16	1/2	Soft 70A	9.9528
1 15/16	9/16	21/32	Firm 95A	9.9529
1 1/2	7/16	3/4	Medium 88A	9.9530
2 1/32	7/16	13/16	Medium 88A	9.9531
1 7/8	9/16	1 5/16	Soft 70A	9.9532



Square/Rectangle					
Length	Width	Hole ID	Height	Hardness	Set Number*
2	2	7/16	1/4	Medium 88A	9.9533
2 1/16	2 1/16	3/8	7/16	Soft 70A	9.9534
2 1/16	2 1/16	3/8	15/16	Soft 70A	9.9535
2 7/16	1 5/8	15/32	1/2	Firm 95A	9.9536

Control Arm Bushing Sets

These "Half" sets are used when the vehicle has an aftermarket control arm at either the front upper or rear lower locations which came with polyurethane bushings.

They fit into the remaining stock control arms, giving the customer the full benefit of having polyurethane bushings on all control arms.

The complete set number must first be obtained under each vehicle application to find the correct set to service front lower or rear upper control arm bushings. Most sets include outer shells and sleeves.



Complete Set #	Lower Set #	Complete Set #	Upper Set #
3.3101	3.3165	2.3101	2.3105
3.3102	3.3165	2.3102	2.3105
3.3103	3.3167	3.3132	3.3169
3.3104	3.3166	3.3162	3.3170
3.3105	3.3167	4.3114	4.3129
3.3106	3.3167	4.3115	4.3129
3.3111	3.3166		
3.3113	3.3167		
3.3117	3.3182		
3.3119	3.3167		
3.3156	3.3171		
3.3172	3.3168		
3.3132	3.3136		

Complete Set #	Axle Housing Only#
3.3132	3.3198

CUSTOM APPLICATIONS

Coil Spring Damper Donuts

Damper donuts inserted in coil springs allow for a progressive rate of compression while preventing spring bottoming. Great for competition use and for vehicles equipped with winches.

2 1/4" tall, 3 9/16" dia.

2 per set. **9.9005**



Formula 5 Prelube

Formula 5 Prelube is a versatile, waterproof, non-melting grease. Formula 5 Prelube forms a tough, durable, chemical resistant film of lubricant that prevents metal-to-metal contact even under severe shock loads.

Only a small amount is required to properly lubricate and prevent corrosion.

8 fl. oz. **9.11104**, .17 fl.oz. squirt tubes (qty. 3) **9.11110**, .17 fl. oz squirt tubes (bulk qty. 100) **9.11111**

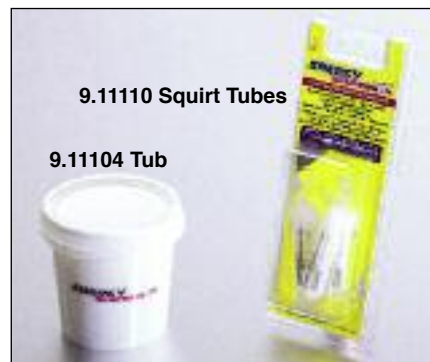

9.11110 Squirt Tubes

9.11104 Tub

Jack Strap!

The ultimate cure for loose, noisy high-lift style jack handles—the **Jack Strap!** Made from virtually indestructible Hyper-Flex® performance polyurethane—Keeps your floppy handle in place securely and stylishly. Our design is the only one that allows it to stay on the jack all the time. Other designs must be taken off to allow the jack to cycle upward. Unique Thru-Hole design allows a secure and flush-fit mounting on most vehicles bumpers, beds and rails. The perfect solution to a persistent problem—strap one on today!



Jack Strap - secure your jack handle!

- Use with high-lift style off-road type jacks
- Secure your loose and noisy handle
- Stays on the jack—No need to remove

Part No. **9.9466**



Note: For product color add R for red or G for black after each part number.

TIE ROD DUST BOOTS

Easy to Install Superior Material Saves Your Tie Rods Lasts Longer Looks Great



At last it is now possible to replace a dust boot without having to buy a new tie rod!!!

These Hyper-Flex® polyurethane dust boots resist damage from rocks, road salt, sand, water and are impervious to undercar fluids.

Color Code: add G-black, R-red after part number.

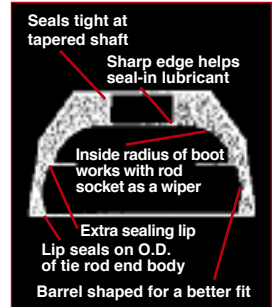

- 1) The rod end must measure at least the minimum dimensions shown below or larger. Approximates will do because of the elasticity of the product. The boot will seal better when it stretches over a larger dimension tie rod.
- 2) In some cases you need to insert a thin, not sharp, object under the lip of the boot to pull over area "B" of the tie rod end.
- 3) Remember, choose the part number (PN#) that has the dimensions closest to the vehicle's, yet it must measure larger than the minimums in the diagram below.

*For applications not listed in catalog, use chart below.

Minimum O.D. Dimension		Style
DIMENSION A	DIMENSION B	ROUND
31/64" or .472" or 12mm	1 13/64" or 1.200" or 30.5mm	9.13103
19/32" or .590" or 15mm	1 3/8" or 1.375" or 35mm	9.13101
9/16" or .562" or 14mm	1 7/16" or 1.437" or 36.5mm	9.13105
21/32" or .650" or 16.6mm	1 5/8" or 1.625" or 41.3mm	9.13119

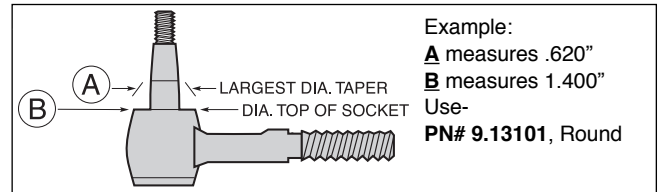

Packaged 2 Per Peg Board Card for Resale and 12 and 50 Per Box for Installers

2 PACK	12 BOX	50 BOX
9.13101	9.13107	9.13113
9.13103	9.13109	9.13115
9.13105	9.13111	9.13117
9.13119	9.13121	9.13123

COIL SPRING ISOLATORS

- Fits to chassis same as OE but better.
- Outlasts and outperforms rubber.
- 2 Per Set.

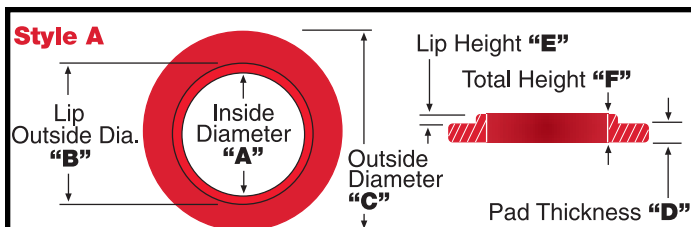

Set No.	A	B	C	D	E	F
3.6110	2 1/8"	2 5/8"	3 1/2"	1/4"	5/8"	7/8"
9.6101	3 3/4"	4 1/16"	5 7/16"	3/8"	1/2"	7/8"
9.6103	2 3/16"	2 3/8"	3 1/2"	7/32"	15/32"	1 1/16"
9.6104	2 3/4"	3 1/16"	4 9/16"	7/16"	5/16"	3/4"
9.6106	2 1/8"	2 11/16"	4 1/8"	1/4"	9/16"	13/16"
9.6108	3 3/4"	4 1/4"	5 13/16"	5/16"	9/16"	7/8"
9.6114	2 3/4"	3"	4 1/16"	1/4"	5/16"	9/16"
9.6116	2 3/16"	2 3/8"	4 9/16"	1/4"	3/8"	5/8"
9.6118	2 1/8"	2 5/16"	3 3/4"	1/4"	7/16"	3/4"
9.6120	3 3/4"	4 1/16"	5 7/16"	5/8"	1/2"	1 1/8"
9.6121	2 1/16"	2 15/32"	3 3/4"	1/4"	1/2"	3/4"

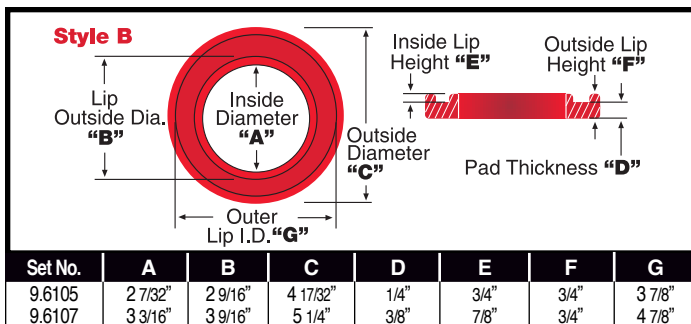

Set No.	A	B	C	D	E	F	G
9.6105	2 7/32"	2 9/16"	4 17/32"	1/4"	3/4"	3/4"	3 7/8"
9.6107	3 3/16"	3 9/16"	5 1/4"	3/8"	7/8"	3/4"	4 7/8"

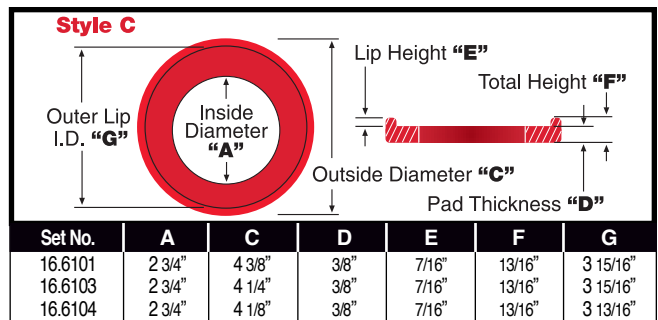

Set No.	A	C	D	E	F	G
16.6101	2 3/4"	4 3/8"	3/8"	7/16"	13/16"	3 15/16"
16.6103	2 3/4"	4 1/4"	3/8"	7/16"	13/16"	3 15/16"
16.6104	2 3/4"	4 1/8"	3/8"	7/16"	13/16"	3 13/16"

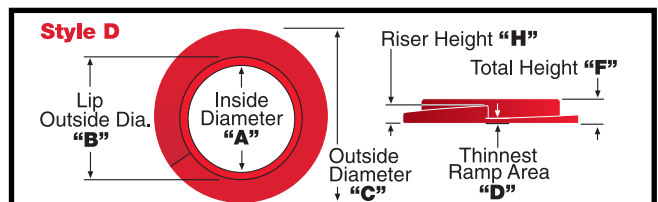

Set No.	A	B	C	D	F	H
9.6115	2 3/16"	2 3/8"	3"	1/4"	1"	5/8"
9.6117	2 1/8"	2 1/4"	3 1/4"	1/4"	1"	5/8"
9.6119	2 1/8"	2 1/2"	3 1/4"	1/4"	1"	5/8"
15.6103	3"	3 7/16"	4 5/16"	3/16"	1 1/8"	9/16"

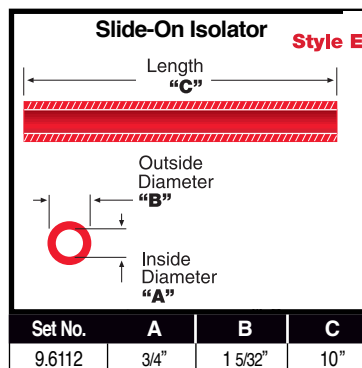

Set No.	A	B	C
9.6112	3/4"	1 5/32"	10"

IMPORTANT!
 Please refer to the specific vehicle page for the proper coil spring isolator set BEFORE choosing isolators from this page.

Note: For product color add R for red or G for black after each part number.



MOTOR & TRANSMISSION MOUNTS

For General Motors Vehicles



Performance Polyurethane Early Style Motor Mount

(Note Interlock Design)
Part Nos. 3.1114, 3.1115, 3.1117 & 3.1118
Patent Number 5,788,206



3.1141 & 3.1144 V-6 Motor Mount

(Note Interlock Design)
Part Nos. 3.1141, 3.1144
Patent Number 5,788,206



3.1133 or 3.1134 Chrome Motor & Transmission Mount Set

Energy Suspension's patented motor mounts are designed to fit most popular G.M. cars and trucks. Made with Energy's Hyper-Flex® performance polyurethane, these motor mounts deliver the best of both worlds; virtually indestructible, yet smooth running as stock/originals and are impervious to vehicle chemicals, road salt and oils to last longer than stock. Also available in matched sets which includes: two motor mounts and a transmission mount for the greatest drivetrain performance benefits!

- Re-engineered To Handle High Horsepower & Torque
- Out Lasts Rubber
- Impervious To Underhood Contaminants
- Available in zinc plating or chrome finish

Early Style Performance Motor Mounts-

For Chevrolet Motored Cars & Hot Rods

Part Nos. 3.1114, 3.1115, 3.1117 & 3.1118

The "Early Style" is the first and only polyurethane motor mount with a safety interlock—to effectively control high horsepower and torque! In the past to get a strong mount enthusiasts would have to put up with unwanted vibration from solid metal mounts, but not any longer!

Choose from either chrome or zinc plated metal and red or black polyurethane. This type of mount is available in two sizes.

3.1141 Replaces G.M. type mount O.E. number 22188970 and aftermarket number 2627.

3.1144 Replaces G.M. type mount O.E. number 22173023 and aftermarket number 2802.

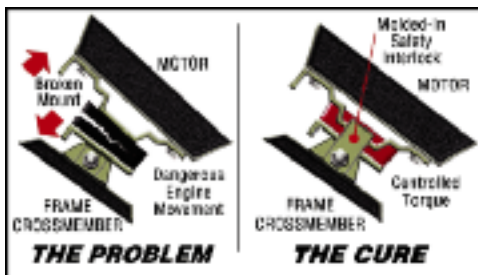

"EARLY STYLE" NOTE: Use the catalog application charts first and if your application is not listed there use the diagrams below to determine the size of mount required.

	Short & Wide		Tall & Narrow	
Part Number	3.1114	3.1115	3.1117	3.1118
Finish	Zinc	Chrome	Zinc	Chrome
Inside width	2 5/8"		2 3/8"	
Height Base to Bolt Center	1 3/4"		2 3/16"	
Replaces O.E. Numbers	3990914, 3960768, 6258154		3962740, 3990918, 3962748	
Replaces Aftermarket	2267, 2285, 2142		2283	

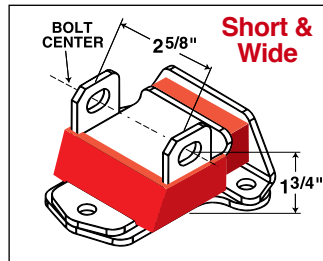

Dimensional differences between the two mounts. **MUST USE SUPPLIED BASEPLATE**

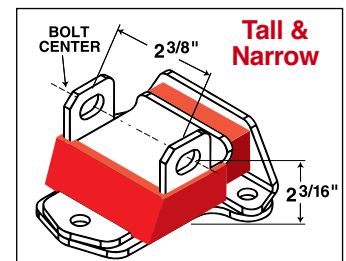

GM LS-series Motor Conversion Sets



Our conversion plate and mount sets are designed to allow you to easily transplant an LS-Series motor into where an early conventional style three bolt motor was. The set includes two of our superior patented Hyper-Flex® polyurethane mounts, plates and hardware. See information above to determine correct set to order for your application.

3.1147	Chrome finish includes short & wide mount (3.1115)
3.1148	Zinc finish includes short & wide mount (3.1114)
3.1149	Chrome finish includes tall & narrow mount (3.1118)
3.1150	Zinc finish includes tall & narrow mount (3.1117)

Note: For product color add R for red or G for black after each part number.

MOTOR & TRANSMISSION MOUNTS

For General Motors Vehicles

Performance Inserts For Clam Shell

Motor Mounts- For General Motors Cars & Trucks

Part Nos. 3.1116, 3.1121, 3.1145, 3.1151 & 3.1152

The redesigned General Motors "Clam Shell" style insert configuration allows you to insert these performance mounts into your existing metal shells. More durable than rubber, yet compliant for street use. Available in red or black polyurethane with zinc coated metal.

See the vehicle listings on the following pages.



IMPORTANT: Our mount is the insert only! **Must** reuse existing, original GM outer metal shell and drill out welds/rivets to separate for installation.



3.1116 4 Bolt Style- Replaces the inserts of the following G.M. type mounts: 14039437, 9762326, 467422, 1001132, 10001133, 9764714, 459021 and aftermarket part number 2292.



3.1151 Replaces the insert for G.M. 5.7L LS-1 in 1998-02 Camaro/Firebird. For OE PN 22179268 and Aftermarket PN 3064.



3.1121 3 Bolt Style- Replaces the inserts of the following G.M. type mounts: 15731260, 15529451, 15529452, 15592505, 22145334 and aftermarket part number 2621.



3.1152 Replaces the insert for G.M. 6.2L, 6.5L Diesel and 7.4L In many 1988-00 4WD Trucks/SUV's. For O.E. mount number 15659675 and 15732188.

Performance Transmission Mounts

These popular transmission mounts control dangerous torque movement on the race track, the street, and off-road! Soft enough for daily driving—yet strong enough to handle extreme conditions.

Energy's patented, "interlock" safety design and Hyper-Flex® performance polyurethane makes our mounts safer and last longer than O.E.M. rubber mounts.

See the following pages for application information for your vehicle.

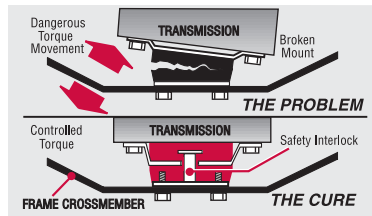

Patented Interlock

PN's: 3.1108, 3.1129, 3.1132, 3.1142, 3.1158 & 3.1171
Patent Numbers 5,788,206 & 5,788,207

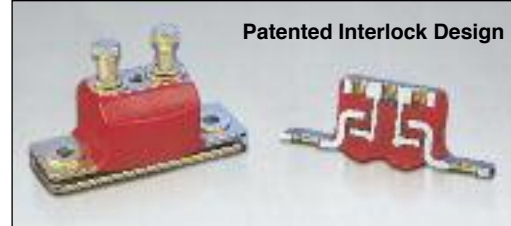

MUST USE SUPPLIED BASEPLATE



Transmission Mount 3.1129

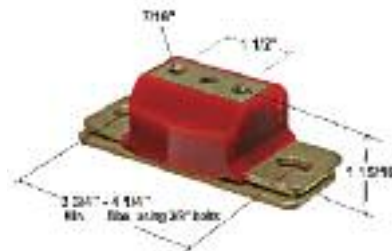

Dimensions for PN's: 3.1108, 3.1132 & 3.1142

NEW

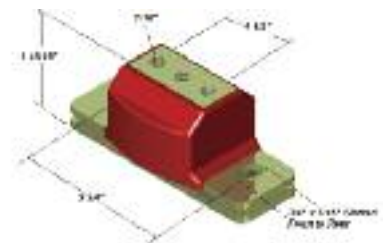

Dimensions for 1999-2014 Chevy Truck PN: 3.1171

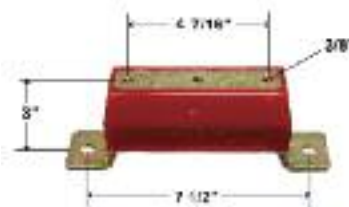

Dimensions for PN: 3.1129



Dimensions for PN: 3.1158



Transmission Mount 3.1106

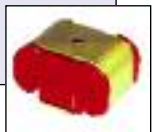

Note: For product color add R for red or G for black after each part number.

MOTOR & TRANSMISSION MOUNTS

For Ford Vehicles



4.1127
4.6L Motor Mounts



4.1122
5.0L Motor Mounts



4.1104 5.0L Transmission Mount

4.6L & 5.0L V8 Motor Mounts

These performance motor mounts are extremely strong, have an improved design and are desirably lower profil—similar in mounting height to the Ford Mustang convertible style O.E.M. mount.

Motor mount sets available alone or with Energy's transmission mount—for the ultimate powertrain upgrade! All sets are available in either red or black Hyper-Flex® polyurethane, with gold zinc plated metal components.



Trans Mounts Set
PN 4.1137

Early Small-Block
Ford Motor Mounts

Mustang Transmission Mounts

Soft enough for smooth operation on the street, yet strong enough for use at the drag strip, circle track, etc. Has a unique built-in safety interlocking feature. U.S. Patent # 5,551,661 & 5,788,207



Comp. Ford Style PN 4.1104
2.110" (2x) 1.125" (2x) 1.125" (2x) 1.125" (2x)

MOTOR & TRANSMISSION MOUNTS

Model	Year	Engine Size	One Motor Mount (chrome finish)	One Motor Mount (zinc finish)	One Transmission Mount (chrome finish)	One Transmission Mount (zinc finish)	Complete Set Incl: 2 Motor Mounts & 1 Trans. Mount (chrome finish)	Complete Set Incl: 2 Motor Mounts & 1 Trans. Mount (zinc finish)
-------	------	-------------	---------------------------------	-------------------------------	--	--------------------------------------	--	--

PASSENGER CARS

BUICK

Apollo	1973-75	250 6 cyl.		3.1116	3.1132	3.1108		3.1130
Century	1973-75	250 6 cyl.		3.1116	3.1132	3.1108		3.1130
	1977-79	350 8 cyl.		3.1116	3.1132	3.1108		3.1130
	1978-80	305 8 cyl.		3.1116	3.1132 '78-'79	3.1108 '78-'79		3.1130 '78-'79
	1981-82	267 8 cyl.		3.1116				
Regal	1973-75	250 6 cyl.		3.1116	3.1132	3.1108		3.1130
	1977-79	350 8 cyl.		3.1116	3.1132 w/auto.	3.1108 w/auto.		3.1130 w/auto.
	1977-78	305 8 cyl.		3.1116	3.1132	3.1108		3.1130
	1982-84	260 6 cyl. Diesel		3.1116	3.1132	3.1108		3.1130
	1981-82	267 8 cyl.		3.1116				
Riviera	1977-78	350 8 cyl.		3.1116				
Roadmaster	1991	305 8 cyl.		3.1116	3.1132	3.1108		3.1130
	1992-93	350 8 cyl.		3.1116	3.1132	3.1108		3.1130
Skylark	1973-75	250 6 cyl.		3.1116	3.1132	3.1108		3.1130
	1977-79	305 8 cyl.		3.1116	3.1132 '77-'78	3.1108 '77-'78		3.1130 '77-'78
	1977-79	350 8 cyl.		3.1116	3.1132	3.1108		3.1130
Le Sabre	1978	305 8 cyl.		3.1116	3.1132	3.1108		3.1130
	1981-82	267 8 cyl.		3.1116	3.1132	3.1108		3.1130

CADILLAC

CTS-V	2009-12	6.2L	3.1155 ^{157,158}					
CTS	2008-12	3.0, 3.6L, 6.2L	3.1155 ^{157,158}					
De Ville	1979	350 8 cyl. Diesel		3.1116				
Fleetwood	1979	350 8 cyl. Diesel		3.1116				
Seville	1978-79	350 8 cyl. Diesel		3.1116	3.1132	3.1108		3.1130
	1976-79	350 8 cyl.		3.1116	3.1132	3.1108		3.1130

See page 15 & 16 for dimensions.

FOOTNOTES: 120 1977-81 only 157 Sold in pairs only 158 Billet aluminum/stainless finish

Note: For product color add R for red or G for black after each part number.



MOTOR & TRANSMISSION MOUNTS

Model	Year	Engine Size	One Motor Mount (chrome finish)	One Motor Mount (zinc finish)	One Transmission Mount (chrome finish)	One Transmission Mount (zinc finish)	Complete Set Incl: 2 Motor Mounts & 1 Trans. Mount (chrome finish)	Complete Set Incl: 2 Motor Mounts & 1 Trans. Mount (zinc finish)
-------	------	-------------	---------------------------------	-------------------------------	--	--------------------------------------	--	--

PASSENGER CARS

CHEVROLET

Belair, Biscayne	1973	250 6 cyl.		3.1116	3.1132	3.1108		3.1130
Camaro	1967-68	302 8 cyl.	3.1115	3.1114	3.1132	3.1108	3.1133	3.1120
	1967-69	327 8 cyl.	3.1115	3.1114	3.1132	3.1108	3.1133	3.1120
	1968-72	307 8 cyl.	3.1115	3.1114	3.1132	3.1108	3.1133	3.1120
	1969	302 8 cyl.	3.1118	3.1117	3.1132	3.1108	3.1134	3.1122
	1969-70	396 8 cyl.	3.1118	3.1117	3.1132	3.1108	3.1134	3.1122
	1970-71	350 8 cyl.	3.1118	3.1117	3.1132	3.1108	3.1134	3.1122
	1970-72	400 8 cyl.	3.1118	3.1117	3.1132	3.1108	3.1134	3.1122
	1973-81	350 8 cyl.		3.1116	3.1132	3.1108		3.1130
	1973	307 8 cyl.		3.1116	3.1132	3.1108		3.1130
	1973-79	250 6 cyl.		3.1116	3.1132 w/man.	3.1108 w/man.		3.1130 w/man.
	1977-92	305 8 cyl.		3.1116	3.1132 ¹²⁰	3.1108 ¹²⁰		3.1130 ¹²⁰
	1980-81	267 8 cyl.		3.1116	3.1132	3.1108		3.1130
	1980-02	2.8, 3.1, 3.4, 3.8L 6 cyl.		3.1145				
	1987-92	350 8 cyl.		3.1116		3.1142		
	1993-97	8 cyl. (right side)		3.1116		3.1142		
1993-97	8 cyl. (left side)		3.1127		3.1142			
1998-02	5.7L 8 cyl.		3.1151		3.1142			
Caprice	1974-76	400 8 cyl.		3.1116	3.1132	3.1108		3.1130
	1974-81	350 8 cyl.		3.1116	3.1132	3.1108		3.1130
	1977-93	305 8 cyl.		3.1116	3.1132	3.1108		3.1130
	1980-82	267 8 cyl.		3.1116	3.1132	3.1108		3.1130
Chevelle	1964-69	327 8 cyl.	3.1115	3.1114	3.1132	3.1108	3.1133	3.1120
	1965-67	396 8 cyl.	3.1115	3.1114	3.1132	3.1108	3.1133	3.1120
	1968-72	307 8 cyl.	3.1115	3.1114	3.1132	3.1108	3.1133	3.1120
	1973	307 8 cyl.		3.1116	3.1132 w/man.	3.1108 w/man.		3.1130 w/man.
	1968-70	396 8 cyl.	3.1118	3.1117	3.1132 w/auto.	3.1108 w/auto.	3.1134 w/auto.	3.1122 w/auto.
	1970-72	350 8 cyl.	3.1118	3.1117	3.1132	3.1108	3.1134	3.1122
	1973-75	350 8 cyl.		3.1116	3.1132 w/auto.	3.1108 w/auto.		3.1130 w/auto.
	1970-72	400 8 cyl.	3.1118	3.1117	3.1132	3.1108	3.1134	3.1122
	1973-75	400 8 cyl.		3.1116	3.1132	3.1108		3.1130
1970-72	454 8 cyl.	3.1118	3.1117	3.1132 w/auto.	3.1108 w/auto.	3.1134 w/auto.	3.1122 w/auto.	
Chevy II	1969-72	307 8 cyl.	3.1115	3.1114	3.1132	3.1108	3.1133	3.1120
Corvette	1963-68	327 8 cyl.	3.1115	3.1114	3.1132 ¹¹⁷	3.1108 ¹¹⁷	3.1133 ¹¹⁷	3.1120 ¹¹⁷
	1963-82	350 8 cyl.	3.1115	3.1114	3.1132 ¹¹⁷	3.1108 ¹¹⁷	3.1133 ¹¹⁷	3.1120 ¹¹⁷
	1965	396 8 cyl.	3.1115	3.1114	3.1132 ¹¹⁷	3.1108 ¹¹⁷	3.1133 ¹¹⁷	3.1120 ¹¹⁷
	1980	305 8 cyl.	3.1115	3.1114	3.1132 ¹¹⁷	3.1108 ¹¹⁷	3.1133 ¹¹⁷	3.1120 ¹¹⁷
El Camino	1965-67	396 8 cyl.	3.1115	3.1114	3.1132	3.1108	3.1133	3.1120
	1967-69	327 8 cyl.	3.1115	3.1114	3.1132	3.1108	3.1133	3.1120
	1968-70	396 8 cyl.	3.1118	3.1117	3.1132	3.1108	3.1134	3.1122
	1968-72	307 8 cyl.	3.1115	3.1114	3.1132	3.1108	3.1133	3.1120
	1970-72	350 8 cyl.	3.1118	3.1117	3.1132	3.1108	3.1134	3.1122
	1970-72	400 8 cyl.	3.1118	3.1117	3.1132	3.1108	3.1134	3.1122
	1970-72	454 8 cyl.	3.1118	3.1117	3.1132 w/auto.	3.1108 w/auto.	3.1134 w/auto.	3.1122 w/auto.
	1973-75	350 8 cyl.		3.1116	3.1132 w/auto.	3.1108 w/auto.		3.1130 w/auto.
	1973	307 8 cyl.		3.1116	3.1132 w/auto.	3.1108 w/auto.		3.1130 w/auto.
	1974-76	400 8 cyl.		3.1116	3.1132 w/man.	3.1108 w/man.		3.1130 w/man.
	1976-81	350 8 cyl.		3.1116	3.1132	3.1108		3.1130
	1979-82	267 8 cyl.		3.1116	3.1132	3.1108		3.1130
	1978-88	305 8 cyl.		3.1116	3.1132	3.1108		3.1130
1980-84	3.7L 6 cyl.		3.1145	3.1132	3.1108		3.1130	
Impala	1974-75	400 8 cyl.		3.1116	3.1132	3.1108		3.1130
	1976	400 8 cyl.		3.1116	3.1132	3.1108		3.1130
	1977-85	305 8 cyl.		3.1116	3.1132	3.1108		3.1130
	1976-81	350 8 cyl.		3.1116	3.1132	3.1108		3.1130
	1980-82	267 8 cyl.		3.1116	3.1132	3.1108		3.1130
	1980-84	3.8L 6 cyl.		3.1145				

See page 15 & 16 for dimensions.

FOOTNOTES: 117 Except Muncie M40 auto. trans 120 1977-81 only

Note: For product color add R for red or G for black after each part number.

Continued
Next Page



MOTOR & TRANSMISSION MOUNTS

Model	Year	Engine Size	One Motor Mount (chrome finish)	One Motor Mount (zinc finish)	One Transmission Mount (chrome finish)	One Transmission Mount (zinc finish)	Complete Set Incl: 2 Motor Mounts & 1 Trans. Mount (chrome finish)	Complete Set Incl: 2 Motor Mounts & 1 Trans. Mount (zinc finish)
-------	------	-------------	---------------------------------	-------------------------------	--	--------------------------------------	--	--

CHEVROLET

Malibu	1968-70	396 8 cyl.	3.1118	3.1117	3.1132	3.1108	3.1134	3.1122
	1970-72	350 8 cyl.	3.1118	3.1117	3.1132	3.1108	3.1134	3.1122
	1970-73	400 8 cyl.	3.1118	3.1117	3.1132	3.1108	3.1134	3.1122
	1970-72	454 8 cyl.	3.1118	3.1117	3.1132	3.1108	3.1134	3.1122
	1973	307 8 cyl.		3.1116	3.1132	3.1108		3.1130
	1973-75	350 8 cyl.		3.1116	3.1132	3.1108		3.1130
	1974-76	400 8 cyl.		3.1116	3.1132 w/man.	3.1108 w/man.		3.1130 w/man.
	1976-81	350 8 cyl.		3.1116	3.1132	3.1108		3.1130
	1976-88	305 8 cyl.		3.1116	3.1132	3.1108		3.1130
1979-82	267 8 cyl.		3.1116	3.1132	3.1108		3.1130	
1980-83	3.8L 6 cyl.		3.1145					

Monte Carlo	1970-72	350 8 cyl.	3.1118	3.1117	3.1132	3.1108	3.1134	3.1122
	1970-73	400 8 cyl.	3.1118	3.1117	3.1132	3.1108	3.1134	3.1122
	1970-72	454 8 cyl.	3.1118	3.1117	3.1132	3.1108	3.1134	3.1122
	1973-75	350 8 cyl.		3.1116	3.1132 w/auto.	3.1108 w/auto.		3.1130 w/auto.
	1974-76	400 8 cyl.		3.1116	3.1132 w/auto.	3.1108 w/auto.		3.1130 w/auto.
	1976-81	350 8 cyl.		3.1116	3.1132	3.1108		3.1130
	1979-88	305 8 cyl.		3.1116	3.1132	3.1108		3.1130
	1979-82	267 8 cyl.		3.1116	3.1132	3.1108		3.1130
1980-84	3.8L 6 cyl.		3.1145					

Nova	1969-72	307 8 cyl.	3.1115	3.1114	3.1132	3.1108	3.1133	3.1120
	1970-71	350 8 cyl.	3.1115	3.1114	3.1132	3.1108	3.1133	3.1120
	1972	350 8 cyl.	3.1118	3.1117	3.1132	3.1108	3.1134	3.1122
	1973	307 8 cyl.		3.1116	3.1132 w/auto.	3.1108 w/auto.		3.1130 w/auto.
	1973-79	350 8 cyl.		3.1116	3.1132	3.1108		3.1130
	1977-79	305 8 cyl.		3.1116	3.1132	3.1108		3.1130
	1973-79	250 6 cyl.		3.1116	3.1132 w/auto.	3.1108 w/auto.		3.1130 w/auto.

FORD

Model	Year	Engine Size	2 Motor Mount Set (zinc finish)	Transmission Mount (zinc finish)	Complete Set Incl. 2 Motor Mounts & 1 Trans. Mount
Fairlane	1964-70	289/302 8 cyl.	4.1135	4.1136	4.1137
Granada	1966-70	289/302 8 cyl.	4.1135	4.1136	4.1137
Maverick	1975-80	302/351 8 cyl.		4.1136	
Mustang	1999-04	4.6L 8 Cyl.	4.1127	4.1128 ⁹⁵	4.1130 ⁹⁵
Mustang	1996-98	4.6L 8 Cyl.	4.1127		
Mustang	1984-95	5.0L 302 8 Cyl.	4.1122	4.1104	4.1124
Mustang	1980-83	5.0L 302 8 Cyl.		4.1104	
Mustang	1979-84	6 Cyl. Auto Trans		4.1104	
Mustang	1971-77	302 8 cyl.		4.1136	
Mustang	1965-68	289 8 cyl.	4.1135	4.1136	4.1137
Mustang	1967-72	302/351 8 cyl.	4.1135	4.1136	4.1137
Ranchero	1966-71	289/302/351 8 cyl.	4.1135	4.1136	4.1137
Ranchero	1967-69	390/428 8 cyl.		4.1136	
Thunderbird	1980-82	5.0L 302 8 cyl.	4.1122		
Thunderbird	1980-84	6 cyl.		4.1104	
Thunderbird	1980-88	8 cyl.		4.1104	
Torino	1968-71	289/302 8 cyl.	4.1135	4.1136	4.1137
Torino	1969-71	351 8 cyl.	4.1135		
Torino	1968-69	390/427/428 8 cyl.		4.1136	

MERCURY

Cornet	1966-67	289 8 cyl.	4.1135	4.1136	4.1137
Cougar	1967-72	289/351 8 cyl.	4.1135	4.1136	4.1137
Cougar	1967-69	390 8 cyl.		4.1136	
Cougar	1968-70	427/428 8 cyl.	4.1135	4.1136	4.1137
Montego	1969-71	351 8 cyl.	4.1135	4.1136	4.1137
Montego	1968-69	390/428 8 cyl.		4.1136	
Montego	1970-73	429 8 cyl.	4.1135	4.1136	4.1137

See page 14 & 15 for dimensions.

FOOTNOTES: 95 Except Cobra with I.R.S.

Note: For product color add R for red or G for black after each part number.



MOTOR & TRANSMISSION MOUNTS

Model	Year	Engine Size	One Motor Mount (chrome finish)	One Motor Mount (zinc finish)	One Transmission Mount (chrome finish)	One Transmission Mount (zinc finish)	Complete Set Incl: 2 Motor Mounts & 1 Trans. Mount (chrome finish)	Complete Set Incl: 2 Motor Mounts & 1 Trans. Mount (zinc finish)
-------	------	-------------	---------------------------------	-------------------------------	--	--------------------------------------	--	--

OLDSMOBILE

Cutlass	1973-76	250 6 cyl.		3.1116	3.1132	3.1108		3.1130
	1982-84	260 8 cyl.		3.1116	3.1132	3.1108		3.1130
	1978-79	350 8 cyl.		3.1116	3.1132	3.1108		3.1130
	1978-87	305 8 cyl.		3.1116	3.1132	3.1108		3.1130
	1981-82	267 8 cyl.		3.1116	3.1132	3.1108		3.1130
Custom Cruiser	1981-82	267 8 cyl.		3.1116				
	1991-92	305 8 cyl.		3.1116	3.1132	3.1108		3.1130
Delta 88	1977	350 8 cyl.		3.1116	3.1132	3.1108		3.1130
	1981-82	267 8 cyl.		3.1116				
Omega	1977-79	305 8 cyl.		3.1116	3.1132	3.1108		3.1130
	1977-79	350 8 cyl.		3.1116	3.1132	3.1108		3.1130
Starfire	1977-79	305 8 cyl.		3.1116				

PONTIAC

Bonneville	1978-80	305 8 cyl.		3.1116	3.1132	3.1108		3.1130
	1982	267 8 cyl.		3.1116	3.1132	3.1108		3.1130
	1982-86	305 8 cyl.		3.1116	3.1132	3.1108		3.1130
Catalina	1978-80	305 8 cyl.		3.1116	3.1132	3.1108		3.1130
Firebird	1973-76	250 6 cyl.		3.1116	3.1132	3.1108		3.1130
	1980-02	2.8, 3.1, 3.4, 3.8L 6cyl.		3.1145				
	1981	267 8 cyl.		3.1116	3.1132	3.1108		3.1130
	1977-92	305 8 cyl.		3.1116	3.1132 ¹²⁰	3.1108 ¹²⁰		3.1130 ¹²⁰
	1977-79	350 8 cyl.		3.1116	3.1132	3.1108		3.1130
	1987-92	350 8 cyl.		3.1116				
	1993-97	8 cyl. (right side)		3.1116				
1993-97	8 cyl. (left side)		3.1127					
1998-02	5.7L 8 cyl.		3.1151					
Grand Prix	1974-77	455 8 cyl.		3.1116	3.1132	3.1108		3.1130
	1976-79	350 8 cyl.		3.1116	3.1132	3.1108		3.1130
	1978-87	305 8 cyl.		3.1116	3.1132	3.1108		3.1130
LeMans	1973-76	250 6 cyl.		3.1116	3.1132	3.1108		3.1130
	1977-81	305 8 cyl.		3.1116	3.1132	3.1108		3.1130
	1977-79	350 8 cyl.		3.1116	3.1132	3.1108		3.1130

TRUCKS- General Motors

Blazer/Jimmy 2WD (S-Series Compact)

S10-S15	1982-01	1.9, 2.0, 2.5L			3.1132	3.1108		
S10-S15	1982-93	2.8L 6 cyl.		3.1145	3.1132	3.1108		
S10-S15	1988-95	4.3L 6 cyl.		3.1141	3.1132	3.1108		
S10-S15	1996-01	4.3L 6 cyl.		3.1144	3.1132	3.1108		
K5	1969-72	292/307 /350 6/8 cyl.		3.1156	3.1132	3.1108		

Pickup 2WD

S10-S15	1982-01	1.9, 2.0, 2.5L			3.1132	3.1108		
S10-S15	1982-93	2.8L 6 cyl.		3.1145	3.1132	3.1108		
S10-S15	1988-95	4.3L 6 cyl.		3.1141	3.1132	3.1108		
S10-S15	1996-01	4.3L 6 cyl.		3.1144	3.1132	3.1108		
C10	1968-72	307/350 8 cyl.		3.1156	3.1132	3.1108		
C10-C35	1973-86	292 6 cyl.		3.1116	3.1132	3.1108		3.1130
C10-C30	1985-95	4.3L 6 cyl.		3.1145	3.1132	3.1108		
C10-C30	1977-86	305 8 cyl.		3.1116	3.1132	3.1108		3.1130
C10-C30	1973-86	350 8 cyl.		3.1116	3.1132	3.1108		3.1130
C10-C30	1963-72	292 6 cyl.		3.1156				
C10-C30	1985-86	454 8 cyl.		3.1121	3.1132	3.1108		3.1128
C20	1963-72	292 6 cyl.		3.1156				
C20	1968-72	307/350 8 cyl.		3.1156	3.1132	3.1108		
C30	1964-72	292 6 cyl.		3.1156				
C30	1968-72	307/350 8 cyl.		3.1156	3.1132	3.1108		
C1500-C2500	1988-00	305 8 cyl.		3.1121	3.1132 w/auto.	3.1108 w/auto.		3.1128 w/auto.
C1500-C3500	1988-00	350 8 cyl.		3.1121	3.1132	3.1108		3.1128
C1500-C3500	1988-00	7.4L 8 cyl.		3.1121				

See page 15 & 16 for dimensions.

FOOTNOTE: 120 1977-81 only

Note: For product color add R for red or G for black after each part number.

Continued
Next Page



Model	Year	Engine Size	One Motor Mount (chrome finish)	One Motor Mount (zinc finish)	One Transmission Mount (chrome finish)	One Transmission Mount (zinc finish)	Complete Set Incl: 2 Motor Mounts & 1 Trans. Mount (chrome finish)	Complete Set Incl: 2 Motor Mounts & 1 Trans. Mount (zinc finish)
-------	------	-------------	---------------------------------	-------------------------------	--	--------------------------------------	--	--

TRUCKS- General Motors (Cont.)

Suburban 2WD

C10-C20	1968-72	292/307 /350 6/8 cyl.		3.1156	3.1132	3.1108		3.1130
C10-C30	1973-84	250 6 cyl.		3.1116	3.1132	3.1108		3.1130
C10-C30	1977-86	305 8 cyl.		3.1116	3.1132	3.1108		3.1130
C10-C30	1987-90	350 8 cyl.		3.1116	3.1132	3.1108		3.1130
C10-C30	1987-91	454 8 cyl.		3.1121	3.1132	3.1108		3.1128
C2500-C3500	1992-99	350 8 cyl.		3.1121	3.1132	3.1108		3.1128
C2500-C3500	1992-99	7.4L 8 cyl.		3.1121				

Tahoe/Yukon 2WD

All	1992-00	350 8 cyl.		3.1121				
All	1992-00	7.4L 8 cyl.		3.1121				

Vans

Astro/Safari	1985-00	4.3L 6cyl		3.1145				
G10-G30	1985-96	4.3L 6cyl		3.1145				
G10-G30	1977-90	305 8 cyl.		3.1116	3.1132	3.1108		3.1130
G10-G30	1979-90	350 8 cyl.		3.1116	3.1132	3.1108		3.1130

Blazer/Jimmy 4WD (S-Series Compact)

S10-S15	1982-94	1.9, 2.0, 2.5L				3.1129		
S10-S15	1982-93	2.8L 6 cyl.		3.1145		3.1129		
S10-S15	1988-95	4.3L 6 cyl.		3.1141		3.1129		
S10-S15	1996-04	4.3L 6 cyl.		3.1144		3.1129		

Blazer 4WD (Fullsize)

K5	1969-72	307/350 8 cyl.		3.1156		3.1106		3.1130 w/auto.
K5	1973-84	292 6 cyl.		3.1116		3.1108 w/auto.		3.1130 w/auto.
K5	1973-84	305, 350 8 cyl.		3.1116		3.1106		3.1124
K5	1985-87	305, 350 8 cyl.		3.1116		3.1129		
K Series	1988-94	350 8 cyl.		3.1121		3.1129		3.1131
K Series	1988-94	6.2L, 6.5L Diesel		3.1152		3.1129		

Escalade 4WD

All	1999-00	350 8 cyl.		3.1121		3.1129		3.1131
-----	---------	------------	--	--------	--	--------	--	--------

Pickup 4WD

S10-S15	1982-93	1.9, 2.0, 2.5L				3.1129		
S10-S15	1982-93	2.8L 6 cyl.		3.1145		3.1129		
S10-S15	1988-95	4.3L 6 cyl.		3.1141		3.1129		
S10-S15	1996-04	4.3L 6 cyl.		3.1144		3.1129		
K10-K20	1964-66	292 6 cyl.		3.1156				
K10	1968-72	307/350 8 cyl.		3.1156		3.1106		
K20-K30	1969-72	292/307 /350 6/8 cyl.		3.1156		3.1106		
K10-K30	1973-84	250 6 cyl.		3.1116		3.1106 '79-'84		3.1124 '79-'84
K10-K30	1985-95	4.3L 6 cyl.		3.1145		3.1129		
K10-K30	1973-84	292 6 cyl.		3.1116	3.1132 w/auto.	3.1108 w/auto.		3.1130 w/auto.
K10-K30	1977-84	305 8 cyl.		3.1116		3.1106		3.1124
K10-K30	1985-87	305 8 cyl.		3.1116		3.1129		
K10-K30	1979-84	350 8 cyl.		3.1116		3.1106		3.1124
K10-K30	1985-87	305 8 cyl.		3.1116		3.1129		
K20-K30	1979-84	454 8 cyl.		3.1121		3.1106		3.1126
K20-K30	1985-87	454 8 cyl.		3.1121		3.1129		3.1131
K1500-K2500	1988-00	305, 350 8 cyl.		3.1121		3.1129		3.1131
K1500-K2500	1988-00	6.2L, 6.5L Diesel		3.1152		3.1129		
K1500-K2500	1988-00	7.4L 8 cyl.		3.1152		3.1129		

Suburban 4WD

K10	1968-72	307/350 8 cyl.		3.1156		3.1106		
K20	1968-72	292/307/350		3.1156		3.1106		
K10-K30	1973-84	250 6 cyl.		3.1116		3.1106 '79-'84		3.1124 '79-'84
K10-K30	1977-84	305 8 cyl.		3.1116		3.1106		3.1124
K10-K30	1985-86	305 8 cyl.		3.1116		3.1129		
K1500-K3500	1992-99	305, 350 8 cyl.		3.1121		3.1129		3.1131
K1500-K3500	1992-99	7.4L 8 cyl.		3.1152		3.1129		
K1500-K3500	1992-99	6.5L Diesel		3.1152		3.1129		

Tahoe/Yukon 4WD

All	1992-00	350 8 cyl.		3.1121		3.1129		3.1131
All	1992-00	6.5L Diesel 8cyl.		3.1152		3.1129		
All	1992-00	7.4L 8 cyl.		3.1152		3.1129		

See page 14 & 15 for dimensions.

Note: For product color add R for red or G for black after each part number.



H Y P E R - F L E X ® S Y S T E M S



**EVERYTHING YOU NEED IN
ONE CONVENIENT PACKAGE
TO SAVE TIME AND MONEY!**

HYPER-FLEX SYSTEM®



MASTER SETS

PASSENGER CAR APPLICATIONS PLEASE NOTE: Many master sets do not include sway bar bushings due to the multiple sizes available for that vehicle. In many cases sway bar bushings must be ordered separately. *Master sets available in black or red.*

Year	Make & Model	Part #
------	--------------	--------

ACURA

1994-01	Integra (except Type "R")	16.18105
---------	---------------------------	----------

Front and rear control arm bushings, front and rear shock bushings, front end links, steering rack bushings (w/power steering only), transmission shifter stabilizer bushings (manual transmission only), ball joint and tie rod end boots.

1990-93	Integra	16.18104
---------	---------	----------

Front and rear control arm bushings, front strut rod bushings, front and rear shock bushings, front end links, steering rack bushings (w/power steering only), transmission shifter stabilizer bushings (manual transmission only), ball joint and tie rod end boots.

2002-04	RSX (includes Type "S")	16.18111
---------	-------------------------	----------

Front and rear control arm bushings, front and rear sway bar bushings.

CHRYSLER

1966-76	A - Body Dart, Demon, Duster, Sport, Valiant, Barracuda (thru '69)	5.18104
1970-74	E - Body Barracuda, Challenger	5.18105
1965-72	B - Body Charger, Coronet, GTX, Roadrunner, Satellite, Superbee	5.18105

Front upper control arm bushings, front strut rod bushings, front end link set, lower control arm bump stops, rear leaf spring bushings, tie rod end boots.

2003-05	SRT-4	5.18114 ⁵⁷
---------	-------	-----------------------

Front control arm bushings (57), front & rear sway bar bushings, rear end links, rear trailing arm bushings, and shifter bushings.

2000-05	Neon	5.18111 ⁵⁷
---------	------	-----------------------

Front control arm bushings (57), front & rear sway bar bushings, front and rear end links, rear trailing arm bushings.

1995-99	Neon (Incl. Sport Package)	5.18106
---------	----------------------------	---------

Front (23) and rear control arm bushings, front strut rod bushings, front and rear sway bar bushings, front and rear end link sets, tie rod end boots.

2001-10	PT Cruiser	5.18108 ⁵⁷
---------	------------	-----------------------

Front control arm bushings (57), front and rear sway bar bushings, front end links, rear trailing arm bushings (57), rear coil spring isolators, rear watts link bushings, rear bump stop set.

1999-02	Prowler	5.18113
---------	---------	---------

Front control arm bushings, front and rear sway bar bushings.

FORD

1997-01	Escort, ZX2	4.18117
---------	-------------	---------

Front control arm bushings, front 25mm and rear 13mm sway bar and end link bushings, rear trailing arm bushings (57), steering rack bushings, transmission shifter stabilizer bushings (manual transmission only).

2000-04	Focus	4.18119 ²
---------	-------	----------------------

Front control arm bushings (2), front and rear sway bar bushings, rear trailing arm bushings, rear coil spring isolators, rear bump stops.

NEW 2015-16	Mustang	4.18127 ^{148,156}
--------------------	---------	----------------------------

Front control arm bushings, rear control arm bushing's rear subframe mounts, rear to rear differential carrier mounts, 32mm front sway bar bushings, 22mm rear sway bar bushing's.

1999-04	Mustang - Except Cobra (includes front ball joint boot set)	4.18121 ⁹⁵
1994-98	Mustang	4.18112
1994-95	Mustang V8 (includes transmission mount)	4.18109
1985-93	Mustang V8 (includes transmission mount)	4.18110
1985-93	Mustang	4.18113 ²

Front control arm bushings, rear control arm bushings (2), front end link set, rack and pinion bushings, McPherson strut tower bushings, front and rear coil spring isolators, transmission crossmember to frame mount bushings (except 94-04 Mustang), tie rod end boots.

1967-73	Mustang	4.18111 ²
---------	---------	----------------------

Front control arm bushings(2), front strut rod bushings, front end link set, rear leaf spring bushings, tie rod end boots.

FOOTNOTE: ² Must reuse existing outer metal shells ⁵⁷ Must reuse all metal parts ⁹⁵ Except Cobra with I.R.S.

¹⁴⁸ Must remove factory metal shells ¹⁵⁶ Lower, front position only

Note: For product color add R for red or G for black after each part number.

Continued
Next Page



HYPER-FLEX® SYSTEMS

PASSENGER CAR APPLICATIONS (Cont.) PLEASE NOTE: Many master sets do not include sway bar bushings due to the multiple sizes available for that vehicle. In many cases sway bar bushings must be ordered separately. *Master sets available in red or black.*

Year	Make & Model	Part #
------	--------------	--------

GENERAL MOTORS

1978-87	Buick Regal	3.18110
1978-88	Chevrolet Chevelle, Monte Carlo, El Camino	3.18110
1978-87	Oldsmobile Cutlass	3.18110
1982-88	Pontiac Grand Prix	3.18110
1978-81	Pontiac Grand Am	3.18110
1974-77	Buick Century, Regal	3.18111
1974-77	Chevrolet Chevelle, El Camino	3.18111
1974-77	Oldsmobile Cutlass, 442	3.18111
1974-77	Pontiac GTO, Lemans	3.18111
1966-72	Buick Century, Skylark	3.18112
1966-72	Oldsmobile Cutlass	3.18112
1967-72	Pontiac GTO, Lemans	3.18112

Front and rear control arm bushings, front end link set, rear coil spring isolators, transmission mount, ball joint and tie rod end boots.

1968-72	Chevrolet Chevelle	3.18113 ³³
---------	--------------------	-----------------------

Front and rear control arm bushings, front end link set, body mount set, rear coil spring isolators, transmission mount, ball joint and tie rod end boots.

1993-02	Chevrolet Camaro & Pontiac Firebird with V8 (Except 1LE suspension option)	3.18130
---------	--	---------

Front control arm bushings (57) and rear control arm bushings, front and rear sway bar bushings, front and rear end link set, torque arm mounts rear panhard bar bushings, tie rod end boots.

1982-92	Chevrolet Camaro & Pontiac Firebird	3.18131
---------	-------------------------------------	---------

Front (8) and rear control arm bushings, front end link set, rear panhard bar bushings, tie rod end boots.

1975-79	Chevrolet Camaro	3.18116
1976-79	Pontiac Firebird	3.18117
1974-75	Pontiac Firebird	3.18116
1967-69	Camaro & Firebird w/multi leaf springs	3.18118
1967-69	Camaro & Firebird w/mono leaf springs	3.18119
1968-74	Chevrolet Nova w/mono leaf springs	3.18119

Front control arm bushings, rear leaf spring bushings, rear leaf spring pads, front end link set, body mount set, transmission mount, ball joint and tie rod end boots.

1980-90	Chevrolet Fullsize—Caprice, Impala	3.18120
---------	------------------------------------	---------

Front control arm bushings, rear control arm bushings (2), front end link set, rear coil spring isolators, transmission mount, ball joint and tie rod end boots.

1955-57	Chevrolet Hard Top and Sedan	3.18121
---------	------------------------------	---------

Front 8 control arm bushings, rear leaf spring bushings, front end link set, body mounts, tie rod end boots.

1984-95	Chevrolet Corvette	3.18122
---------	--------------------	---------

Front and rear control arm bushings, rack and pinion bushings, rear spring cushions, rear strut rod bushings, differential carrier bushings, ball joint and tie rod end boots.

1963-82	Chevrolet Corvette	3.18123
---------	--------------------	---------

Front control arm bushings, rear control arm bushings(2), front end link set, power steering ram bushings, transmission mount, rear spring cushions, rear strut rod bushings, rear sway bar and end link bushings, ball joint and tie rod end boots.

2004-06	Pontiac GTO	3.18134
---------	-------------	---------

Front and rear control arm bushings, front and rear sway bar and end link bushings, rear sub-frame bushings.



**EVERYTHING YOU NEED IN
ONE CONVENIENT PACKAGE
TO SAVE TIME AND MONEY!**

HYPER-FLEX SYSTEM®



HYPER-FLEX® SYSTEMS

PASSENGER CAR APPLICATIONS (Cont.) PLEASE NOTE: Many master sets do not include sway bar bushings due to the multiple sizes available for that vehicle. In many cases sway bar bushings must be ordered separately. *Master sets available in red or black.*

Year	Make & Model	Part #
------	--------------	--------

HONDA

1994-97	Accord	16.18107
1990-93	Accord	16.18108

Front control arm bushings, front strut rod bushings, front shock bushings, front coil spring isolators, front end links, ball joint and tie rod end boots.

2002-05	Civic Si	16.18114
---------	----------	----------

Front control arm bushings (148), rear lower control arm bushings (3), front and rear sway bar bushings, rack and pinion bushings and rear upper shock bushings

NEW

2006-11	Civic Si	16.18114
---------	----------	----------

Front control arm bushings (148), rear lower control arm bushings (3), front and rear sway bar bushings, rack and pinion bushings and rear upper shock bushings.

1999-00	Civic Si	16.18109
1996-00	Civic	16.18110

Front control arm bushings, front shock bushings, front and rear sway bar bushings, front and rear coil spring isolators, rear trailing arm bushings, transmission shifter stabilizer bushings (manual transmission only), rack and pinion bushings, front ball joint and tie rod end boots.

1992-95	Civic	16.18103
1993-97	Del Sol (Incl. VTEC)	16.18103

Front and rear control arm bushings, front and rear shock bushings, front end links, steering rack bushings, transmission shifter stabilizer bushings (manual transmission only), ball joint and tie rod end boots.

1988-91	Civic & CRX	16.18102
---------	-------------	----------

Front and rear control arm bushings, front strut rod bushings, front shock bushings, rear shock bushings (89-91 only), front end links, steering rack bushings, transmission shifter stabilizer bushings (manual transmission only), ball joint and tie rod end boots.

1984-87	Civic & CRX	16.18101
---------	-------------	----------

Front and rear control arm bushings, front and rear sway bar bushings and end links, transmission shifter stabilizer bushings (manual transmission only), ball joint and tie rod end boots.

1997-01	Prelude Type SH	16.18113
---------	-----------------	----------

Front and rear control arm bushings, front strut rod bushings, front and rear coil spring isolators, front and rear bump stops, front and rear shock bushings, rear trailing arm bushings

1992-96	Prelude	16.18106
---------	---------	----------

Front and rear control arm bushings, front strut rod bushings, front and rear coil spring isolators, front and rear bump stops, front and rear shock bushings.

INFINITI

2003-07	G35 Coupe RWD Only	7.18108
---------	--------------------	---------

Front and rear control arm bushings, front and rear sway bar bushings, rack and pinion bushings, differential carrier bushings rear sub-frame bushings.

MAZDA

1986-91	RX7- With 24mm front and 14mm rear sway bar bushings	11.18101
---------	--	----------

Front and rear control arm bushings, front and rear sway bar bushings, ball joint and tie rod end boots.

NEW

2016	Miata MX-5 (ND)	11.18105
------	-----------------	----------

Front Control arm bushings, rear control arm bushings, 24mm front sway bar bushings, 11mm rear sway bar bushings, rear differential carrier bushings.

NEW

2006-14	Miata MX-5 (NC)	11.18104
---------	-----------------	----------

Front control arm bushings (148), rear control arm bushings, front and rear sway bar bushings, rack and pinion bushings and rear differential carrier bushings..

1990-05	Miata (NA/NB)	11.18102
---------	---------------	----------

Front upper and lower control arm bushings, front and rear sway bar bushings, rear control arm bushings and differential bushings.

MITSUBISHI

2002-05	Lancer Evolution (EVO)	5.18115
---------	------------------------	---------

Front control arm bushings, rear trailing arm bushings, 24mm front sway bar bushings, 22mm rear sway bar bushings, rear differential bushings.

2000-Jan 01	Eclipse	5.18110
-------------	---------	---------

Front & rear control arm bushings, front & rear sway bar bushings.

1995-99	Eclipse- All Wheel Drive and FWD	5.18107
---------	----------------------------------	---------

Front and rear control arm bushings, front and rear shock bushings, transmission shifter stabilizer bushings (manual transmission only).

FOOTNOTES: 3 Lowers must use existing outer metal shells 148 Must remove factory metal shells

Note: For product color add R for red or G for black after each part number.



HYPER-FLEX® SYSTEMS

PASSENGER CAR APPLICATIONS (Cont.) PLEASE NOTE: Many master sets do not include sway bar bushings due to the multiple sizes available for that vehicle. In many cases sway bar bushings must be ordered separately. *Master sets available in red or black.*

Year	Make & Model	Part #
------	--------------	--------

NISSAN / DATSUN

2002-09	350Z	7.18108
---------	------	---------

Front and rear control arm bushings, front and rear sway bar bushings, rack and pinion bushings, differential carrier bushings rear sub-frame bushings.

1995-98	240SX- With 27mm front and 16mm rear sway bar bushings	7.18107
---------	--	---------

Front control arm bushings (2), rear control arm bushings, front strut rod bushings, front and rear sway bar bushings, tie rod end boots.

1989-94	240SX	7.18106 2 57
---------	-------	--------------

Front and rear control arm bushings, front strut rod bushings, front and rear sway bar bushings, rack and pinion bushings and rear sub-frame mount inserts.

1990-96	300ZX	7.18105 57 104
---------	-------	----------------

Front control arm bushings, front strut rod bushings, front and rear sway bar and end link bushings, rack & pinion bushings, rear sub frame bushings, rear differential carrier bushings (57).

1991-94	Sentra- With 28mm front and 15mm rear sway bar bushings	7.18104
---------	---	---------

Front and rear control arm bushings, front and rear sway bar bushings, transmission shifter stabilizer bushings (manual transmission only), tie rod end boots.

1970-73	240Z	7.18101
---------	------	---------

1974-78	260Z and 280Z	7.18102
---------	---------------	---------

Front and rear control arm bushings, front strut rod bushings, front and rear bump stops, rack and pinion bushings, differential carrier mustachebar bushings, steering coupler bushing, front end links and tie rod end boots. (260Z and 280Z systems also include transmission crossmember bushings, rear sway bar bushings and rear end link bushings.)

SATURN

1991-02	Coupe, Sedan, Wagon	18.18101
---------	---------------------	----------

Front control arm bushings (57), rear control arm bushings, front & rear sway bar bushings and tie rod end boots.

SCION

2005-07	tC	8.18110
---------	----	---------

Front lower control arm bushings, front & rear sway bar bushings, rear trailing arm bushings and rear sub frame bushings.

NEW 2013-15	FR-S	8.18115
--------------------	------	---------

Front and rear control arm bushings, front sway bar bushings, rear sway bar and end link bushings, rack and pinion bushings, transmission shifter stabilizer bushings (manual transmission only).

SUBARU

NEW 2013-15	BRZ	8.18115
--------------------	-----	---------

Front and rear control arm bushings, front sway bar bushings, rear sway bar and end link bushings, rack and pinion bushings, transmission shifter stabilizer bushings (manual transmission only).

NEW 2008-14	WRX	19.18102
--------------------	-----	----------

Front & rear control arm bushings, front and rear sway bar bushings, rack & pinion bushings, trans. shifter stab. bushings.

2002-06	Impreza, WRX	19.18101
---------	--------------	----------

Front control arm bushings, rear trailing arm bushings, front & rear sway bar bushings and manual transmission shifter bushings.

TOYOTA

2000-05	Celica	8.18106
---------	--------	---------

Front control arm bushings, front & rear greaseable sway bar bushings and rack & pinion bushings.

VW

1990-95	Corrado	15.18101
---------	---------	----------

1985-92	Golf, GTI & Jetta	15.18101
---------	-------------------	----------

Front & rear control arm bushings, rear coil spring isolators and rear strut tower bushings.

FOOTNOTE: 2 Must reuse existing outer metal shells 57 Must reuse all metal parts 104 Sway bar end links included

Note: For product color add R for red or G for black after each part number.



HYPER-FLEX® SYSTEMS

TRUCK APPLICATIONS (Cont.) PLEASE NOTE: Many master sets do not include sway bar bushings due to the multiple sizes available for that vehicle. In many cases sway bar bushings must be ordered separately. *Master sets available in red or black.*

Year	Make & Model	Part #
------	--------------	--------

GENERAL MOTORS

1999-06	Chevrolet 1500 Silverado 2WD	3.18129
---------	------------------------------	---------

Front control arm bushings, rear spring and shackle bushings, front sway bar (32mm) bushings and end links and body mounts.

2001-06	Chevrolet/GMC 2500 HD 2WD/4WD	3.18128
---------	-------------------------------	---------

Front control arm bushings, front sway bar bushings and end links, rear spring and shackle bushings, body mounts.

1995-99	Tahoe & Yukon 2WD	3.18124
---------	-------------------	---------

1992-99	Suburban 1/2 & 3/4 ton 2WD	3.18126
---------	----------------------------	---------

1988-98	Chevrolet/GMC 2WD 1/2 ton, 3/4 ton & 1 ton STD and Extra Cab Pickup	3.18107
---------	---	---------

1981-87	Chevrolet/GMC 2WD 1/2 ton Pickup	3.18108
---------	----------------------------------	---------

1973-80	Chevrolet/GMC 2WD 1/2 ton Pickup	3.18109
---------	----------------------------------	---------

Front control arm bushings, front sway bar bushings, rear spring and shackle bushings, body mounts, tie rod end boots, transmission mount.

1982-04	Chevrolet S-10/GMC S-15 2WD Pickup	3.18106
---------	------------------------------------	---------

Front control arm bushings, rear spring and shackle bushings, front sway bar bushings, body mounts, tie rod end boots, transmission mount.

1995-97	Tahoe & Yukon 4WD	3.18125
---------	-------------------	---------

1992-97	Suburban 1/2 & 3/4 Ton 4WD	3.18127
---------	----------------------------	---------

Front control arm bushings, front sway bar bushings, rear spring and shackle bushings, body mounts, tie rod end boots.

NEW 2007-10	Chevrolet/GMC K2500HD/3500HD	3.18133 ⁵⁸
--------------------	------------------------------	-----------------------

Front control arm bushings(2), front sway bar bushings, front differential mount bushings, torsion bar x-member frame bushings, rear spring and shackle bushings and body mounts.

1988-98	Chevrolet/GMC 4WD 1/2 ton, 3/4 ton & 1 ton STD and Extra Cab Pickup	3.18101
---------	---	---------

Front control arm bushings, front sway bar bushings, rear spring and shackle bushings, body mounts, tie-rod end boots.

1981-87	Chevrolet/GMC 4WD 1/2 ton & 3/4 ton Pickup (With Stock Front Springs)	3.18102
---------	---	---------

1981-87	Chevrolet/GMC 4WD 1/2 ton & 3/4 ton Pickup (With Aftermarket Front Springs)	3.18103 ⁴⁰
---------	---	-----------------------

1973-80	Chevrolet/GMC 4WD 1/2 ton & 3/4 ton Pickup (With Stock Front Springs)	3.18104
---------	---	---------

1973-80	Chevrolet/GMC 4WD 1/2 ton & 3/4 ton Pickup (With Aftermarket Front Springs)	3.18105 ⁴⁰
---------	---	-----------------------

Front and rear spring and shackle bushings, front sway bar bushings, body mounts, tie rod end boots, transmission mount (except '81-'87).

DODGE & PLYMOUTH

2002-05	Ram 1500 2WD Pickup	5.18117
---------	---------------------	---------

Front control arm bushings (2), rear leaf spring bushings, sway bar and end link bushings, front coil spring isolators, rack & pinion bushings, front bump stops.

1994-01	Ram 1500, 2500, 3500 Pickup 2WD	5.18109 ¹⁰⁰
---------	---------------------------------	------------------------

Front control arm bushings (23), rear leaf spring bushings, body mounts, sway bar bushings, tie rod end boots.

1972-93	Ramcharger 4WD	5.18101
---------	----------------	---------

1972-85	1/2 ton & 3/4 ton Standard Cab Pickup 4WD	5.18102
---------	---	---------

Front and rear leaf spring bushings (fits 1" eye only), body mounts, tie rod end boots.

FORD

1998-11	Ranger Pickup 2 & 4WD Fits both Coil Spring & Torsion Bar Suspension	4.18126
---------	--	---------

Front control arm bushings, front sway bar bushings, rear leaf spring bushings, body mounts, tie rod end boots.

2000-04	Excursion 4WD	4.18120
---------	---------------	---------

Front and rear leaf spring bushings, front sway bar and track arm bushings, rear overload spring snubbers, front and rear axle bump stops.

1997-01	Expedition & Navigator 4WD	4.18115
---------	----------------------------	---------

Front control arm bushings (2), rear control arm bushings, front and rear sway bar bushings, body mounts, rear track arm bushings, tie rod end boots.

1991-94	Explorer 4WD	4.18102
---------	--------------	---------

Radius arm bushings, axle pivot bushings, rear spring and shackle bushings, front and rear sway bar bushings, tie rod end boots.

1992-06	E250, E350 Van 2WD	4.18116
---------	--------------------	---------

Radius arm bushings, axle pivot bushings (2), front sway bar bushings and bar end grommets, rear spring and shackle bushings, tie rod end boots.

FOOTNOTES: **2** Must reuse existing outer metal shells **23** Front lowers must reuse existing outer shells
40 Aftermarket springs 2 1/2" wide except Superlift and Skyjacker **58** Uppers must reuse all hardware
100 With 2 1/2" I.D. main eye & 2 1/2" wide spring

Note: For product color add R for red or G for black after each part number.



HYPER-FLEX® SYSTEMS

TRUCK APPLICATIONS (Cont.) PLEASE NOTE: Many master sets do not include sway bar bushings due to the multiple sizes available for that vehicle. In many cases sway bar bushings must be ordered separately. *Master sets available in red or black.*

MASTER SETS

Year	Make & Model	Part #
------	--------------	--------



FORD (continued)

2004-06	F150 2 & 4WD Pickup	4.18125
<i>Front control arm bushings, rear leaf spring bushings, front sway bar and end link bushings.</i>		
1997-03	F150 4WD Pickup - includes STD, Extra cab and Super cab	4.18123
<i>Front control arm bushings (2), body mounts, rear leaf spring bushings, front sway bar and end link bushings</i>		
1997-03	F150 2WD Pickup - includes STD, Extra cab and Super cab	4.18122
<i>Front control arm bushings (2,58), body mounts, rear leaf spring bushings, front sway bar bushings</i>		
1980-96	F150 Standard & Extra Cab Pickup 4WD	4.18101
<i>Radius arm bushings, axle pivot bushings, rear spring and shackle bushings, body mounts, tie rod end boots.</i>		
2000-04	F250 4WD Superduty	4.18124
<i>Front and rear spring bushings, front track rod bushings, front sway bar and end link bushings, rear sway bar and end link bushings.</i>		
1966-77	Bronco 4WD (with 2 Degree C-Bushings)	4.18104
1966-77	Bronco 4WD (with 4 Degree C-Bushings)	4.18105
1973-79	F150 Pickup 4WD (with 2 Degree C-Bushing)	4.18106
1973-79	F150 Pickup 4WD (with 4 Degree C-Bushing)	4.18107
<i>C-bushings, radius arm bushings, track arm bushings, rear spring and shackle bushings, body mounts, tie rod end boots (Bronco kit includes body mount hardware).</i>		

JEEP

 2007-14	Jeep JK 2 Door (includes stock height body mounts)	2.18109
2007-14	Jeep JK 4 Door (includes stock height body mounts)	2.18108
<i>Front and rear control arm bushings, front and rear sway bar bushings, front & rear track bar bushings, front and rear bump stops, body mounts.</i>		
1997-06	Wrangler TJ	2.18107
1997-06	Wrangler TJ (with integrated 1" body lift kit)	2.18106
<i>Front and rear control arm bushings (2), front and rear greaseable sway bar and end link bushings, front and rear track bar set, front and rear coil spring isolators, front and rear bump stops, body mounts.</i>		
1987-95	Wrangler YJ	2.18101
<i>Front and rear spring and shackle bushings, front sway bar and end link bushings, front and rear track rod bushings, body mounts, transmission mount, tie-rod end boots.</i>		
1980-86	CJ7	2.18102
1976-79	CJ5, CJ7	2.18103
<i>Front and rear spring and shackle bushings, front sway bar and end link bushings, body mounts, transmission mount, transmission torque arm bushings, tie rod end boots.</i>		
1955-75	CJ5	2.18104
<i>Front and rear spring and shackle bushings, body mounts, tie rod end boots.</i>		
1984-01	Cherokee 4WD	2.18105
<i>Front control arm bushings (2), rear spring and shackle bushings, front track rod bushing, tie rod end boots.</i>		

TOYOTA

 2005-13	Tacoma Prerunner 2WD Only & Tacoma 4WD All Models	8.18113
<i>Front control arm bushings, front sway bar bushings, rack and pinion bushings, front spring isolator, front & rear bump stops, rear leaf spring bushings and body mounts.</i>		
2001-04	Tacoma 4WD	8.18107
1995 ^{1/2} -00	Tacoma 4WD	8.18104
<i>Front control arm bushings (2), front coil spring isolators, front sway bar bushings, front rack & pinion bushings, body mounts, rear spring and shackle bushings, tie rod end boots.</i>		
1989-95	Standard Cab Pickup 4WD	8.18101
<i>Front control arm bushings (57), rear spring and shackle bushings, front sway bar bushings, tie rod end boots, body mounts.</i>		
1979-85	Standard Cab Pickup 4WD	8.18102
<i>Front and rear spring and shackle bushings, front sway bar bushings, torque arm bushings, body mounts, tie rod end boots.</i>		
1990-95	4Runner 2WD & 4WD	8.18114
<i>Front and rear control arm bushings, front and rear sway bar bushings, rack and pinion bushings, front & rear bump stops, rear track arm bushings, rear shock bushings and body mounts.</i>		
 2000-02	4Runner 4WD	8.18114
<i>Front and rear control arm bushings, front and rear sway bar bushings, rack and pinion bushings, front & rear bump stops, rear track arm bushings, rear shock bushings and body mounts.</i>		
1998-99	4Runner 4WD	8.18116
<i>Front and rear control arm bushings, front and rear sway bar bushings, rack and pinion bushings, front & rear bump stops, rear track arm bushings, rear shock bushings and body mounts.</i>		
1964-78	FJ40 Land Cruiser	8.18105
<i>Front and rear spring and shackle bushings, body mounts and hardware, tie rod end boots.</i>		

FOOTNOTES: 2 Must reuse existing outer metal shells 57 Must reuse all metal parts 58 Uppers must reuse all hardware

Note: For product color add R for red or G for black after each part number.



ENERGYSUSPENSION.COM



Energy Suspension was the first to develop a full line of component sets and complete master sets that offer full coverage for Acura vehicles, for good reason. The performance designed into factory stock Acuras are just the beginning of what most enthusiasts really want.



Integra **Hyper-Flex® System** Complete Master Set contains most part numbers below.

Year	Front End Control Arm Bushing Set	Rear End Control Arm Bushing Set	Front Strut Rod Bushing Set	Front Sway Bar Frame Bushings	Rear Sway Bar Frame Bushings	Front End Links	Tie Rod Boots	Front Ball Joint Boot Set
------	-----------------------------------	----------------------------------	-----------------------------	-------------------------------	------------------------------	-----------------	---------------	---------------------------

INTEGRA

1994-01	16.3105	16.3109 107 lower only		24mm 16.5104 22mm 16.5108 21mm 16.5105	14mm 16.5116 13mm 16.5107	16.8104 70	9.13103 72	16.13101
1990-93	16.3108	16.3109 lower only	16.7104	23mm 16.5113 22mm 16.5118	16mm 16.5114 15mm 16.5112	16.8104 70	9.13103 72	16.13101
1994-01	Hyper-Flex® System Complete Master Set- See pg. 21						16.18105 107	
1990-93	Complete Master Set- See pg. 21						16.18104	
1990-01	Front Shock Upper & Lower Bushing Set		16.8102		1994-01	Rear Trailing Arm Bushing Set		16.7106 57
1990-01	Rear Shock Upper & Lower Bushing Set		16.8103		1990-93	Rear Trailing Arm Bushing Set		16.7107 57
1990-01	Manual Transmission Shifter Stabilizer Bushing Set		16.1101					
1994-01	Steering Rack Bushing Set (power steering only)		16.10102					
1990-93	Steering Rack Bushing Set (power steering only)		16.10103					
1994-01	Motor Mount Inserts- (3 Torque Mount Positions) See page 5.		16.1106 113					
1990-93	Motor Mount Inserts- (2 Torque Mount Positions) See page 5.		16.1109 113					



Re-engineered Rear Trailing Arm Bushings dramatically help the vehicle maintain proper rear toe and caster under high performance driving conditions. Important when using larger-than-stock tires and wheels.



Unique two-piece polyurethane Motor Mount Inserts insert into the existing mount system, preventing tearing of original soft rubber mount material. A must-use for high performance conditions!

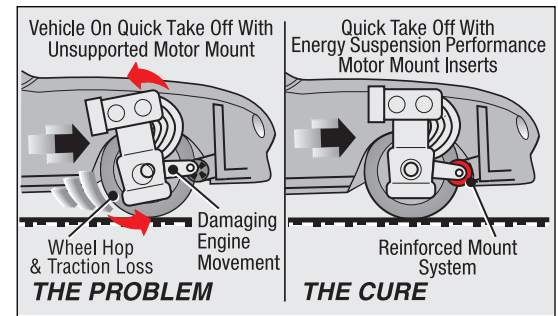

Year	Front End Control Arm Bushing Set	Rear End Control Arm Bushing Set	Front Strut Rod Bushing Set	Front Sway Bar Frame Bushings	Rear Sway Bar Frame Bushings	Front End Links	Tie Rod Boots	Front Ball Joint Boot Set
------	-----------------------------------	----------------------------------	-----------------------------	-------------------------------	------------------------------	-----------------	---------------	---------------------------

RSX (includes Type S)

2002-04	16.3116	16.3117		23mm 16.5131	19mm 16.5132			
2002-04	Hyper-Flex® System Complete Master Set- See pg. 21						16.18111	
2002-04	Motor Mount Inserts- (manual transmission only) See page 5.		16.1110 113					

FOOTNOTES: 57 Must reuse all metal parts 70 GSR & Del Sol VTEC will use one half of the set
 72 2 Boots per package- See page 13 for more information 107 Except Type "R" 113 With manual transmission

Note: For product color add R for red or G for black after each part number.



B M W

Year	Front End Control Arm Bushing Set	Rear End Control Arm Bushing Set	Front Strut Rod Bushing Set	Front Sway Bar Frame Bushings	Complete Rear Sway Bar Bushings	Front End Links	Tie Rod Boots	Front Ball Joint Boot Set
------	-----------------------------------	----------------------------------	-----------------------------	-------------------------------	---------------------------------	-----------------	---------------	---------------------------

318i, 325i, 328i

1992-99				23mm 12.5101 24mm 12.5103 25mm 12.5104				
---------	--	--	--	--	--	--	--	--

525i, 530i, 535i, 540i

1989-95				23mm 12.5101 24mm 12.5103 25mm 12.5104	14.5mm 12.5102			
---------	--	--	--	--	----------------	--	--	--

2002

1964-76	12.3101 ⁶⁶	12.3102					9.13103 ⁷²	
---------	-----------------------	---------	--	--	--	--	-----------------------	--

B U I C K

Year	Front End Control Arm Bushing Set	Rear End Control Arm Bushing Set	Rear Leaf Spring Bushing Set	Body Mount Set	Front Strut Rod Bushing Set	Front Sway Bar Frame Bushings	Front End Links	Tie Rod Boots
------	-----------------------------------	----------------------------------	------------------------------	----------------	-----------------------------	-------------------------------	-----------------	---------------

FULL SIZE- CENTURION, ELECTRA (RWD), LE SABRE (RWD), WILDCAT, ESTATE WAGON

1991-96	3.3173	3.3159 ²				30mm 3.5183	9.8123	9.13101 ⁷²
1980-90	3.3113	3.3159 ²				See page 7	9.8117	9.13101 ⁷²
1974-79	3.3105	3.3158 ^{2 30}				See page 7	9.8117	9.13101 ⁷²
1971-73	3.3103	3.3158 ^{2 30}				See page 7	9.8117	9.13101 ⁷²
1969-70		3.3132				See page 7	9.8117	9.13101 ⁷²
1966-68		3.3132			3.7114	See page 7	9.8117	9.13101 ⁷²
1965		3.3132			3.7114	See page 7	9.8117	9.13101 ⁷²
1961-64					3.7114	See page 7	9.8119	

1985-96	Ball Joint Dust Boot Set	9.13128	1979-91	Front Lower Bump Stop Set	3.9102
1965-90	Rear Upper Coil Spring Isolators	3.6108	Various Years	Motor & Transmission Mounts-Applications on pgs. 14 thru 20	See Charts

RIVIERA

1974-78	3.3105				See page 7	9.8117	9.13101 ⁷²	
1971-73	3.3103				See page 7	9.8117	9.13101 ⁷²	
1970		3.3132		3.4135	See page 7	9.8117	9.13101 ⁷²	
1969		3.3132			See page 7	9.8117	9.13101 ⁷²	
1966-68		3.3132			3.7114	See page 7	9.8117	9.13101 ⁷²

1979-85	Front Upper Bump Stop Set	3.9102	1965-70	Track Arm Bushing Set (Panhard Bar)	3.7111
1963-65	Front Upper Bump Stop Set	9.9102	1963-65	Ball Joint Dust Boot Set	9.13132
1979-85	Front Lower Bump Stop Set	9.9150	1979-85	Ball Joint Dust Boot Set	9.13128

CENTURY (RWD), REGAL (RWD) (EXC. SOMERSET), GRAND NATIONAL, SKYLARK (thru '72), SPECIAL

1982-87	3.3156	3.3132		3.4141	See page 7	See page 8	9.13101 ⁷²
1978-81	3.3156	3.3132			See page 7	See page 8	9.13101 ⁷²
1974-77	3.3105	3.3132			See page 7	9.8117	9.13101 ⁷²
1973	3.3103	3.3132			See page 7	9.8117	9.13101 ⁷²
1968-72	3.3101 ⁶ 3.3172 ⁶⁷	3.3132		3.4160 ¹⁴²	See page 7	9.8118	9.13101 ⁷²
1966-67	3.3101 ⁶ 3.3172 ⁶⁷	3.3132		3.4155 ¹⁴²	See page 7	9.8118	9.13101 ⁷²
1965	3.3121 ⁸	3.3132		3.4155 ¹⁴²			
1964	3.3121 ⁸	3.3133 ²⁴		3.4155 ¹⁴²			

1978-87	Hyper-Flex® System Complete Master Set- See pg. 22					3.18110
1974-77	Hyper-Flex® System Complete Master Set- See pg. 22					3.18111
1966-72	Hyper-Flex® System Complete Master Set- See pg. 22					3.18112
1973-87	Ball Joint Dust Boot Set	9.13128	1975-87	Front Lower Bump Stop Set	9.9150	
1964-72	Ball Joint Dust Boot Set	9.13125	1974-87	Rear Upper Coil Spring Isolator Set	3.6108	
1978-87	Front Upper Bump Stop Set	3.9102	Various Years	Motor & Transmission Mounts-Applications on pgs. 14 thru 20	See Charts	

FOOTNOTES: 2 Must reuse existing outer metal shells 6 With all round bushings 8 Lowers only 24 Uppers must reuse existing outer shells 30 1973-74 only 66 Includes strut bushings 67 With oval rear lower bushing 72 2 Boots per package- See page 13 for more information 142 Includes hardware



Note: For product color add R for red or G for black after each part number.

CADILLAC

Year	Front End Control Arm Bushing Set	Rear End Control Arm Bushing Set	Rear Leaf Spring Bushing Set	Body Mount Set	Front Strut Rod Bushing Set	Front Sway Bar Frame Bushings	Front End Links	Tie Rod Boots
------	-----------------------------------	----------------------------------	------------------------------	----------------	-----------------------------	-------------------------------	-----------------	---------------

ALL EXCEPT ELDORADO and '80-'87 SEVILLE

1980-96	3.3113					See page 7	9.8117	9.13101 ⁷²
1977-79	3.3105					See page 7	9.8117	9.13101 ⁷²

1977-94	Ball Joint Dust Boot Set		9.13128	Various Years	Motor & Transmission Mounts- Applications on pgs. 14 thru 20		See Charts	
---------	--------------------------	--	---------	---------------	--	--	------------	--

CTS

NEW 2008-12	2 Motor Mount Set. (Alum. Billet)	3.1155 157,158
--------------------	-----------------------------------	----------------

CTS-V

NEW 2009-12	2 Motor Mount Set (Alum. Billet)	3.1155 157,158
--------------------	----------------------------------	----------------

XLR, XLR-V

2004-09	3.3176 57,146	3.3177 57						
---------	---------------	-----------	--	--	--	--	--	--

CHEVROLET

FULLSIZE – BELAIR, BISCAYNE, CAPRICE, EL CAMINO ('59-'60), IMPALA, STATION WAGON

1991-96	3.3173	3.3159 ²		3.4145 ⁴⁷		30mm 3.5183 ²⁹	9.8123	9.13101 ⁷²
1980-90	3.3113	3.3159 ²				See page 7	9.8117	9.13101 ⁷²
1978-79	3.3105	3.3159 ^{2,69}				See page 7	9.8117	9.13101 ⁷²
1975-77	3.3105	3.3158 ^{2,69}				See page 7	9.8117	9.13101 ⁷²
1974	3.3105 ⁵	3.3158 ^{2,69}				See page 7	9.8117	9.13101 ⁷²
1973	3.3104 ⁴ 3.3103 ⁵	3.3158 ^{2,69}				See page 7	9.8117	9.13101 ⁷²
1971-72	3.3103	3.3158 ^{2,69}				See page 7	9.8117	9.13101 ⁷²
1965-70	3.3150 ⁷³	3.3148 ^{2,78} 3.3149 ^{2,79,86}		3.4138 ^{33,74}	3.7109	See page 7	9.8120	9.13101 ⁷²
1959-64	3.3108	3.3152 ^{79,2} 3.3153 ^{78,2}		3.4166 ³³ 3.4167 ³⁴			9.8119	9.13101 ⁷²
1958	3.3108						9.8119	9.13101 ⁷²
1955-57	3.3108		3.2118 ³¹ 3.2119 ³²	3.4106 ³³ 3.4119 ³⁴ 3.4120 ⁷⁴		See page 7	9.8117	9.13101 ⁷²

1980-90	Hyper-Flex® System Complete Master Set- See pg. 22						3.18120
---------	---	--	--	--	--	--	---------

1955-57	Hyper-Flex® System Complete Master Set- Hardtop And Sedan See pg. 22						3.18121
---------	---	--	--	--	--	--	---------

1978-96	Front Upper Bump Stop Set	3.9102	1955-57	Motor Mounts (stock 8 Cyl. Only)	3.1102
---------	---------------------------	--------	---------	----------------------------------	--------

1971-92	Front Lower Bump Stop Set	9.9150	1965-70	Rear Track Arm Bushings (Panhard Bar)	3.7110 ⁸⁰
---------	---------------------------	--------	---------	---------------------------------------	----------------------

1975-96	Balljoint Dust Boot Set	9.13128	1959-64	Rear Track Arm Bushings (Panhard Bar)	3.7113
---------	-------------------------	---------	---------	---------------------------------------	--------

1991-96	Rear Upper Coil Spring Isolator Set	3.6110	Various Years	Motor & Transmission Mounts- Applications on pgs. 14 thru 20		See Charts
1971-90	Rear Coil Spring Isolator Set	3.6108				



Performance Motor Mounts, motor mount inserts & trans mounts, see pgs. 14-20 for specific applications.



FOOTNOTES: 2 Must reuse existing outer metal shells 4 1 3/8" OD front lower 5 1 5/8" OD front lower
²⁹ Greaseable Frame Bushings ³¹ 1955 only ³² 1956-57 only ³³ Except Convertible ³⁴ Convertible only ⁴⁷ 70A duro police, taxi, race car recommend firmer durometer set 3.4136 88A duro ⁵⁷ Must reuse all metal parts ⁶⁹ Except station wagon
⁷² 2 Boots per package- See page 13 for more information ⁷³ Lowers must reuse all metal parts ⁷⁴ 2 door hard top
⁷⁸ With single upper control arm ⁷⁹ With two upper control arms ⁸⁰ Track bar with both ends same ID (1 1/8") use 3.7112
⁸⁶ 1969-70 with V-8 use 3.3151 ¹⁴⁶ Except ZO6, ZR1 and Grand Sport ¹⁵⁷ Sold in pairs only ¹⁵⁸ Billet aluminum/stainless finish

Note: For product color add R for red or G for black after each part number.



CHEVROLET - CAMARO

CARS



Energy Suspension has focused copious amounts of research and development to provide the best performing polyurethane designs. Our components for the First through the new Fifth Generation Camaro employ applied technology that is unequalled in the industry.

Year	Front End Control Arm Bushing Set	Rear End Control Arm Bushing Set	Front Sway Bar Frame Bushings	Complete Rear Sway Bar Bushing Set	Rear Differential Carrier Bushing Set
------	-----------------------------------	----------------------------------	-------------------------------	------------------------------------	---------------------------------------

CAMARO

Year	Front End Control Arm Bushing Set	Rear End Control Arm Bushing Set	Front Sway Bar Frame Bushings	Complete Rear Sway Bar Bushing Set	Rear Differential Carrier Bushing Set
NEW 2011-2014	3.3195	3.3196	22.5mm 3.5218	23mm 3.5223 104	3.1153
2010	3.3195	3.3196	22.5mm 3.5218	23mm 3.5219 104	3.1153

We offer two options for the rear sub-frame mounts—an insert or full replacement. The insert bushing set inserts into the open voids of the original rubber mount and is tailored for the daily driver wanting to improve performance without adversely compromising their ride along with easier installation. The sub-frame replacement bushings are designed for the diehard track or drag racer demanding ultimate performance over isolation.

2010	Rear Sub-Frame Mount Insert Bushing Set	3.4168
NEW 2010-15	Rear Sub-Frame Mount Replacement Bushing Set	3.4169

Year	Front End Control Arm Bushing Set	Rear End Control Arm Bushing Set	Rear Leaf Spring Bushing Set	Body (Subframe) Mount Set	Transmission Mount	Front Sway Bar Frame Bushings	Front End Links	Tie Rod Boots
1993-02	3.3164 57	3.3136				30mm 3.5163 32mm 3.5162	9.8118	9.13101 72
1982-92	3.3157 8	3.3136				30mm 3.5159 32mm 3.5130 34mm 3.5131	9.8117	9.13101 72
1980-81	3.3106		3.2103	3.4142	3.1108	See page 7	9.8117	9.13101 72
1975-79	3.3105		3.2103	3.4142	3.1108	See page 7	9.8117	9.13101 72
1973-74	3.3104 4 3.3103 5		3.2103	3.4142	3.1108	See page 7	9.8117	9.13101 72
1970-72	3.3102		3.2103	3.4142	3.1108	See page 7	9.8117	9.13101 72
1967-69	3.3101		3.2101 9 3.2102 10	3.4142	3.1108	11/16" 3.5202 29 13/16" 3.5203 29	9.8117	9.13101 72

1993-02	Hyper-Flex® System Complete Master Set- See pg. 22						3.18130
1982-92	Hyper-Flex® System Complete Master Set- See pg. 22						3.18131
1975-79	Hyper-Flex® System Complete Master Set- See pg. 22						3.18116
1967-69	Hyper-Flex® System Complete Master Set- For Vehicles With Multi Leaf Springs Only- See pg. 22						3.18118
1967-69	Hyper-Flex® System Complete Master Set- For Vehicles With Mono Leaf Springs Only- See pg. 22						3.18119
1982-92	Secondary Transmission Cross Member Mounts		3.1109	1975-81	Front Upper Bump Stop Set		3.9102
1982-01	Rear Panhard Bar Bushing Set		3.7106	1971-92	Front Lower Bump Stop Set		9.9150
1982-92	Ball Joint Dust Boot Set		9.13130	1967-69	Front Lower Bump Stop Set		9.9154
1970-81	Ball Joint Dust Boot Set		9.13128	1967	Rear Traction Bar Bushing Set- Passenger Side		3.7115
1967-69	Ball Joint Dust Boot Set		9.13125	Various Years	Motor Mounts- See pgs. 14 thru 20		See Charts

FOOTNOTES: 4 1 3/8" OD front lower 5 1 5/8" OD front lower 8 Lower only 9 Mono leaf spring 10 Multi leaf spring 29 Greaseable Frame Bushings 57 Must reuse all metal parts 72 2 Boots per package - See page 13 for more information 104 Sway bar end links included

Note: For product color add R for red or G for black after each part number.

ENERGYSUSPENSION.COM



CHEVROLET - CAMARO (cont.)

Complete Rear Sway Bar Bushing Sets



Performance Rear Sway Bar Bushings

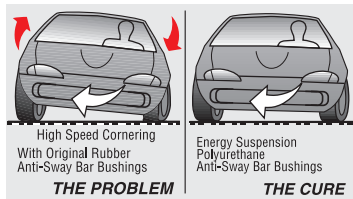

Rubber can't compare to Energy's Hyper-Flex® performance polyurethane in creating that in-control feeling on the road. Similar to the effect of installing a larger diameter sway bar, Energy's polyurethane equals higher performance. Energy's performance polyurethane components allow your vehicle's sway bar system to work at its maximum efficiency, like it's supposed to! Energy Suspension manufactures rear stabilizer bar bushings to precisely fit original equipment drop link brackets. If your bar is original equipment or even from an aftermarket supplier, Energy has the performance polyurethane components that fit!

One Bolt Clamp Style 1967-81

Bar Dia.	Set #
5/8" Bar	3.5107
11/16" Bar	3.5110
3/4" Bar	3.5109
13/16" Bar	3.5124
7/8" Bar	3.5111
15/16" Bar	3.5112
1" Bar	3.5113

Two Bolt Clamp Style 1967-81

Bar Dia.	Set #
9/16" Bar	3.5103
5/8" Bar	3.5104
11/16" Bar	3.5165
3/4" Bar	3.5106
13/16" Bar	3.5123
7/8" Bar	3.5105

Year	Bar Dia.	Set #
1982-02	19mm	3.5161
	21mm	3.5145
	23mm	3.5146
	24mm	3.5147



Heavy Duty Shackle Set

Heavy Duty Shackle Sets- Includes Hardware

Reduces wheel hop in acceleration, prevents shudder under braking and delivers greater handling control.

Great for vehicles with high performance tires and horsepower upgrades.

1967-81	For Vehicles w/Multi-Leaf Springs- includes all spring bushings, shackle bushings and hardware	3.2134
1967-81	For Vehicles w/Multi-Leaf Springs- includes shackle bushings and hardware only	3.2135
1967-69	For Vehicles w/Mono-Leaf Springs- includes all spring bushings, shackle bushings and hardware	3.2136
1967-69	For Vehicles w/Mono-Leaf Springs- includes shackle bushings and hardware only	3.2137

Performance Torque Arm Mount Bushings

These popular Hyper-Flex® performance polyurethane transmission-to-differential torque arm bushings for Camaros reduce wheel hop in acceleration, prevent shudder under braking and even add greater handling control. A real must when using higher performance tires and horsepower upgrades. Works like a traction bar by firming things up! Patent No. 6,000,672.

1993-02	Torque Arm Mount Bushing	3.1111 57
1984-92	Torque Arm Mount Bushing (Lips Facing Towards Driveshaft) SEE DIAGRAM	3.1112 57
1984-92	Torque Arm Mount Bushing (Lips Facing Away From Driveshaft) SEE DIAGRAM	3.1111 57
1982-83	Torque Arm Mount Bushing	3.1110 57



Performance Torque Arm Bushings connecting the differential to the transmission.

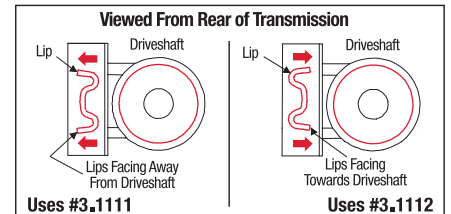

Leaf Spring Pads

Longer lasting Hyper-Flex® performance polyurethane pads for whenever the spring assembly is reassembled. Replace those original crushed rubber pads.



3.6111 Spring Pad Set.

Year	Model	Leaf Spring Pad Set Number Set Includes 2 upper pads & 2 lower pads
1970-81	Camaro (multi-leaf)	3.6111
1968-69	Camaro (multi-leaf)	3.6112
1967-69	Camaro (mono-leaf)	3.6113

FOOTNOTES: 57 Must reuse all metal parts

Note: For product color add R for red or G for black after each part number.



CARS

CHEVROLET - CORVETTE

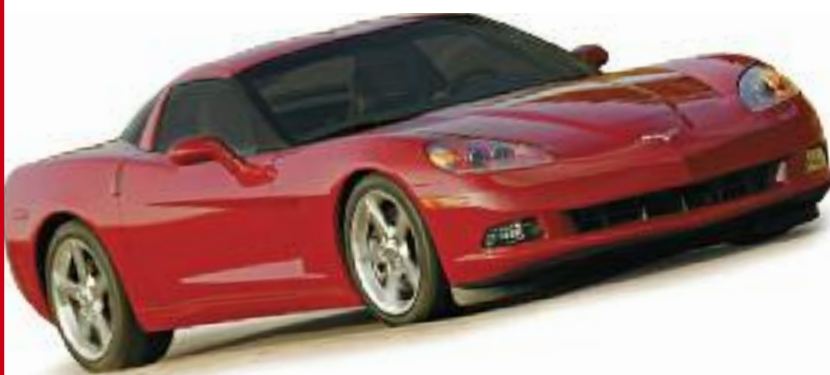

Energy Suspension has spent years designing, testing and formulating compounds to come up with the best possible suspension bushings for 1954 to 2012 Corvettes.

Energy Suspension Hyper-Flex® polyurethane gives your Corvette added performance without creating adverse change to the original ride. One-piece design control arm bushings and an offset hole in the stabilizer bar bushings to reduce bind on the end links are just some unique features. If you are looking to restore, race, or commute your Corvette, Energy has you covered with proven quality components and the largest selection available in the industry!

Hyper-Flex® System Complete Master Set contains most part numbers below.

Year	Front End Control Arm Bushing Set	Rear End Control Arm Bushing Set	Rear Leaf Spring Bushing Set	Body Mount Set	Rear Strut Rod Bushing Set	Front Sway Bar Frame Bushings	Front End Links	Tie Rod Boots
------	-----------------------------------	----------------------------------	------------------------------	----------------	----------------------------	-------------------------------	-----------------	---------------

CORVETTE

NEW 2005-12	3.3176 57,146	3.3177 57,146						
1997-04	3.3176 57	3.3177 57	Spring Cushions 3.2140			23mm 3.5200 26mm 3.5196		9.13101 72
1996	3.3142		Spring Cushions 3.2123		3.7108 97,57	See Chart Next Page	3.8103	9.13101 72
1988-95	3.3142	3.3145	Spring Cushions 3.2123		3.7108 97,57	See Chart Next Page	3.8103	9.13101 72
1984-87	3.3142	3.3145	Spring Cushions 3.2123		3.7107 96,57	See Chart Next Page	3.8102	9.13101 72
1975-82	3.3108	3.3191 2	Spring Cushions 3.2104	3.4126	3.7102	See Chart Page 8	9.8120	9.13101 72
1973-74	3.3108	3.3191 2	Spring Cushions 3.2104	3.4126	3.7101 84	See Chart Page 8	9.8120	9.13101 72
1968-72	3.3108	3.3191 2	Spring Cushions 3.2104		3.7101 84	See Chart Page 8	9.8120	9.13101 72
1963-67	3.3108	3.3191 2	Spring Cushions 3.2104	3.4102 ³³ 3.4152 ³⁴	3.7101 84	See Chart Page 8	9.8120	9.13101 72
1954-62			3.2121					

1984-95	Hyper-Flex® System Complete Master Set- See pg. 22							3.18122
---------	---	--	--	--	--	--	--	---------

1963-82	Hyper-Flex® System Complete Master Set- See pg. 22							3.18123
---------	---	--	--	--	--	--	--	---------

1963-82	Transmission Mount (All w/Manual Transmission)	3.1108	Various Years	Motor Mounts- See pgs. 14 thru 20	See Charts		
---------	---	--------	---------------	--	------------	--	--

1976-82	Transmission Mount (All w/Auto. Trans. exc. M40)	3.1108 117	1984-96	Ball Joint Dust Boots	9.13127		
---------	---	------------	---------	------------------------------	---------	--	--

1976-82	Transmission Mount (All w/Auto. Trans. exc. M40)	3.1108 117	1963-82	Ball Joint Dust Boots	9.13125		
---------	---	------------	---------	------------------------------	---------	--	--

FOOTNOTES: 2 Must reuse existing outer metal shells 33 Hardtop Only 34 Convertible Only 57 Must reuse all metal parts 72 2 Boots per package- See page 13 for more information 84 Fits 1 1/2" OD rod eye - If strut rod has been replaced with 1 3/4" OD rod eye use 3.7102 96 Fits G.M. #14048947 (LH) & #14048948 (RH) arms (Strut eyes same size each end) 97 Fits G.M. #10098131 (LH) & #10098132 (RH) arms (Strut eyes different size each end) 117 Except Muncie M40 auto. trans. 146 Except ZO6, ZR1 and Grand Sport

Note: For product color add R for red or G for black after each part number.

CHEVROLET - CORVETTE (cont.)



**Front Sway Bar Bushing Set
(Includes End Link Bushings)**

Year	Front Sway Bar Bushing Set	Set #
1997-04	23mm O.D. Bar	3.5200
	26mm O.D. Bar	3.5196
1988-96	22mm O.D. Bar	3.5140 ¹²³
	24mm O.D. Bar	3.5141 ¹²³
	26mm O.D. Bar	3.5154 ¹²³
	30mm O.D. Bar	3.5142 ¹²³
1984-87	22mm O.D. Bar	3.5137 ¹²³
	24mm O.D. Bar	3.5138 ¹²³
	26mm O.D. Bar	3.5139 ¹²³
	30mm O.D. Bar	3.5155 ¹²³
1963-82	See Universal Sway Bar Bushing Sets- Page 7	



Rear Sway Bar Bushing Set w/End Links

Year	Rear Sway Bar Bar Diameter	Set with New Sway Bar Brackets	Set Reuse O.E. Sway Bar Brackets
1997-04	19 mm O.D. Bar		3.5201
	22 mm O.D. Bar		3.5197
1984-96	19 mm O.D. Bar	3.5149 ¹²³	3.5191 ¹²³
	22 mm O.D. Bar	3.5150 ¹²³	3.5192 ¹²³
	24 mm O.D. Bar	3.5151 ¹²³	3.5193 ¹²³
	26 mm O.D. Bar	3.5152 ¹²³	3.5194 ¹²³
1968-82	9/16" O.D. Bar	3.5224 ¹²³	
1963-67	7/16" O.D. Bar	3.5153 ¹²³	3.5195 ¹²³
1963-96	Rear End Link Bushings Only		3.8101

FOOTNOTES: 123 Includes Sway Bar End Link Bushings



Rack and Pinion Bushing Set and Power Steering Ram Bushing Set

1984-96	Rack and Pinion Bushing Set	3.10101
1963-82	Power Steering Ram Bushing Set	3.10102



Carrier Bushing Set and Pinion Mount Set

1984-96	Differential Carrier Bushing Set	3.1103
1980-82	Differential Carrier Bushing Set	3.1104
1963-82	Differential Pinion Mount Grommet Set	3.1101

Performance Polyurethane Motor Mounts
See pages 14 thru 20.

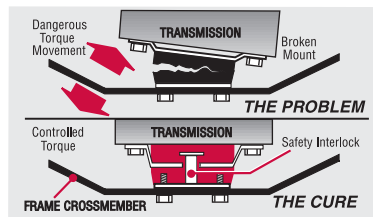

Transmission Mount

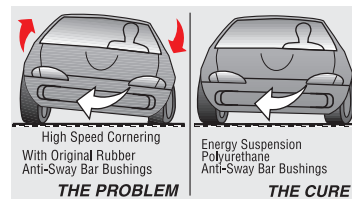

Sway Bar Bushings

Note: For product color add R for red or G for black after each part number.

CHEVROLET



Energy Suspension performance Hyper-Flex® polyurethane bushings deliver crisp suspension & steering response on the street, as well as precision straight-line launches at the strip. They activate suspension components immediately, resulting in greater control, on and off the track, giving you that “racers edge”. Energy bushings are full floating and non-binding, allowing proper weight transfer and full suspension travel. Let us help your vehicle handle better than new!



Hyper-Flex® System Complete Master Set for Chevelles contains most part numbers below.

Year	Front End Control Arm Bushing Set	Rear End Control Arm Bushing Set	Rear Leaf Spring Bushing Set	Body Mount Set	Transmission Mount	Front Sway Bar Frame Bushings	Front End Links	Tie Rod Boots
------	-----------------------------------	----------------------------------	------------------------------	----------------	--------------------	-------------------------------	-----------------	---------------

CHEVELLE, MONTE CARLO, MALIBU, LAGUNA & EL CAMINO- ('64 & UP)

1978-88	3.3156	3.3132		3.4141	3.1108	See page 7	9.8119	9.13101 ⁷²
1975-77	3.3105	3.3132			3.1108	See page 7	9.8117	9.13101 ⁷²
1974	3.3105 ⁵	3.3132			3.1108	See page 7	9.8117	9.13101 ⁷²
1973	3.3104 ⁴ 3.3103 ⁵	3.3132			3.1108	See page 7	9.8117	9.13101 ⁷²
1968-72	3.3101 ⁶ 3.3172 ⁶⁷	3.3132		3.4113 ⁶⁰ 3.4114 ³⁴ 3.4115 ^{33,46} 3.4170 ^{33,46,142}	3.1108	See page 7	9.8118	9.13101 ⁷²
1967	3.3101 ⁶ 3.3172 ⁶⁷	3.3132		3.4111 ³³	3.1108	See page 7	9.8118	9.13101 ⁷²
1966	3.3101 ¹² 3.3117 ¹¹	3.3132		3.4111 ³³	3.1108	See page 7	9.8118	9.13101 ⁷²
1965	3.3117	3.3132		3.4111 ³³	3.1108	See page 7	9.8118	9.13101 ⁷²
1964	3.3117	3.3133 ²⁴		3.4128 ³³	3.1108	See page 7	9.8118	9.13101 ⁷²

1978-88	Hyper-Flex® System Complete Master Set- See pg. 22	3.18110
---------	---	---------

1974-77	Hyper-Flex® System Complete Master Set- See pg. 22	3.18111
---------	---	---------

1968-72	Hyper-Flex® System Complete Master Set- See pg. 22	3.18113 ³³
---------	---	-----------------------

1973-88	Balljoint Dust Boot Set	9.13128	Various Years	Motor Mounts- See pgs. 14 thru 20	See Charts
---------	--------------------------------	---------	---------------	--	------------

1964-72	Balljoint Dust Boot Set	9.13125
---------	--------------------------------	---------

1978-88	Front Upper Bump Stop Set	3.9102
---------	----------------------------------	--------

1973-85	Front Lower Bump Stop Set	9.9150
---------	----------------------------------	--------

1964-72	Front Lower Bump Stop Set	9.9154
---------	----------------------------------	--------

1968-88	Rear Upper Coil Spring Isolator Set	3.6108
---------	--	--------

1968-72	Supplemental Body Mount Kit	3.4171 ¹⁴⁹
---------	------------------------------------	-----------------------

Performance Polyurethane Motor and Transmission Mount Sets- in Chrome or Zinc. See pages 14 thru 20.



FOOTNOTES: 4 1 3/8" OD front lower 5 1 5/8" OD front lower 6 With all round bushings 11 1.90" O.D. rear lower 12 1.65" O.D. rear lower 24 Uppers must reuse existing outer shells 33 Except convertible 34 Convertible only 46 1970-72 Monte Carlo use 3.4134 60 El Camino only 67 With oval rear lower bushing 72 2 Boots per package -See page 13 for more information 142 Includes hardware 149 Some big block models may require supplement body mount set

Note: For product color add R for red or G for black after each part number.

CHEVROLET (cont.)

Year	Front End Control Arm Bushing Set	Rear End Control Arm Bushing Set	Rear Leaf Spring Bushing Set	Body Mount Set	Front Strut Rod Bushing Set	Front Sway Bar Frame Bushings	Front End Links	Tie Rod Boots
------	-----------------------------------	----------------------------------	------------------------------	----------------	-----------------------------	-------------------------------	-----------------	---------------

MONZA, VEGA

1976-80	3.3126	3.3141 24				See page 7	9.8117	9.13101 72
1975	3.3126	3.3140 64 24				See page 7	9.8117	9.13101 72
1971-74	3.3126	3.3140 24				See page 7	9.8117	9.13101 72

All	Transmission Mount	3.1108
-----	--------------------	--------

1971-80	Front Upper Bump Stop	3.9102
---------	-----------------------	--------

NOVA, CHEVY II

1975-79	3.3105		3.2103	3.4129		See page 7	9.8117	9.13101 72
1968-74	3.3101		3.2103 10 3.2101 9	3.4142		¹¹ / ₁₆ " 3.5202 ¹³ / ₁₆ " 3.5203	9.8117	9.13101 72
1962-67	3.3160		3.2122 9		3.7105	See page 7	9.8117	9.13101 72

1975-79	Ball Joint Dust Boots	9.13128	All	Transmission Mount	3.1108
---------	-----------------------	---------	-----	--------------------	--------

1968-74	Ball Joint Dust Boots	9.13125	Various Years	Motor Mounts- See pgs. 14 thru 20	See Charts
---------	-----------------------	---------	---------------	-----------------------------------	------------

1968-72	Front Lower Bump Stop Set	9.9154
---------	---------------------------	--------



Leaf Spring Pads

Great for restoration, polyurethane pads are much longer lasting than O.E.M. Replace those original crushed rubber pads. Do it right!

Year	Model (Set Incl. 2 Upper & 2 Lower Pads)	Leaf Spring Pad Set
1962-79	Nova & Chevy II (w/multi-leaf)	3.6112
1962-74	Nova & Chevy II (w/mono leaf)	3.6113

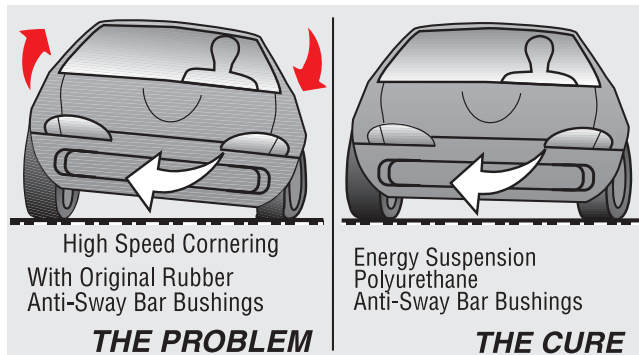

Sway Bar Bushings

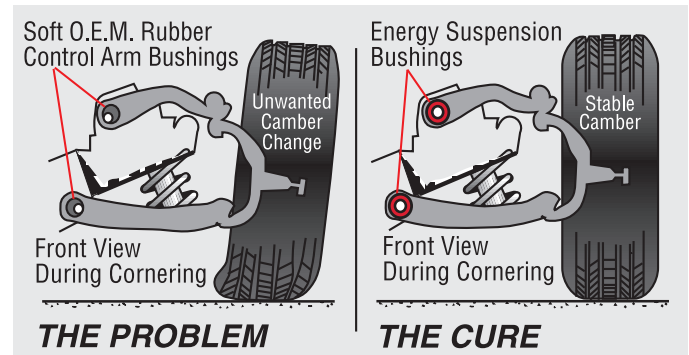

Front Control Arm Bushings



Front End Control
Arm Bushing Set

FOOTNOTES: 9 Mono leaf spring 10 Multi leaf spring 24 Uppers must reuse existing outer shells
64 GT and Monza use 3.3141 72 2 Boots per package- See page 13 for more information

Note: For product color add R for red or G for black after each part number.

CHRYSLER - RWD

Performance Transmission Mount



Performance Polyurethane Transmission Mount Bushing Set

Energy Suspension has re-engineered the Chrysler transmission mount using the highest quality polyurethane. It is impervious to all under vehicle fluids and contaminants, including transmission fluid, oils, fuel, ozone, road salt, etc. The formulation of this super-tough material is firm enough for huge amounts of horsepower and torque, yet soft enough to prevent excess vibration.

Part Number 5.1101

Year	Chrysler Models	Engine	Part No.
1979-88	Fifth Avenue, Newport, New Yorker	225, 318, 360	5.1101
1975-83	Cordoba	ALL	
1977-88	Le Baron	225, 318, 360	
1974-78	All Full Size	ALL	
1963-73	All Models	383, 400, 440	

Year	Dodge Models	Engine	Part No.
1977-83	Diplomat, Charger SE	ALL	5.1101
1976-80	Aspen, Magnum	ALL	
1969-78	Polara, Monaco	ALL	
1970-74	Challenger	ALL	
1971-76	Charger, Coronet	ALL	
1969-70	Charger, Coronet, Super Bee	318, 400, 440	
1971-76	Dart, Demon, Swinger	318, 340, 360	
1967-70	Dart, Demon, Swinger	318	

Year	Plymouth Models	Engine	Part No.
1969-85	Fury	ALL	5.1101
1976-80	Volare	ALL	
1973-76	Duster	198, 225, 318, 360	
1972-74	Belvedere, Road Runner, Satellite	ALL	
1970-74	Barracuda	ALL	



Part Number 5.1112 Interchange - Aftermarket Part#2272, OE Part #253145 Strong Interlocking Metal Construction

Year	Chrysler Models	Engine	Part No.
1963-64	Newport	361ci	5.1112
1965-68	Newport	383ci	
1962-66	300 w/Auto	383ci	
1966-68	Imperial, Newport	440ci	

Year	Dodge Models	Engine	Part No.
1966-69	Dart	170ci 6cyl	5.1112
1970-72	Dart, Demon	198ci 6cyl	
1966-69	Charger, Coronet	225ci 6cyl	
1962-71	Dart	225ci 6cyl	
1967-72	Demon	225ci 6cyl	
1966-69	Coronet	273ci	
1967-73	Dart	273ci	
1969-71	Charger	318ci	
1965-71	Coronet	318ci	
1967-73	Dart	318ci	
1966-70	Polara	318ci	

Year	Dodge Models	Engine	Part No.
1968-73	Dart	340ci	5.1112
1973	Dart	360ci	
1971-73	Monaco	360ci	
1966	Charger, Coronet	361ci	
1970-71	Challenger	383ci	
1966-71	Charger, Coronet	383ci	
1967	Dart	383ci	
1966-71	Monaco, Polara	383ci	

Year	Plymouth Models	Engine	Part No.
1966-69	Valiant	170ci	5.1112
1970-72	Duster, Scamp, Valiant	198ci 6cyl	
1969	Barracuda	225ci 6cyl	
1962-1970	Belvedere	225ci 6cyl	
1970-1972	Duster	225ci 6cyl	
1968-72	Fury	225ci 6cyl	
1966-72	Valiant	225ci 6cyl	
1966-69	Valiant	273ci	
1968-69	Barracuda	318ci	
1967-70	Belvedere	318ci	
1971-72	Duster	318ci	
1966-70	Fury	318ci	
1968-72	Valiant	318ci	
1969-71	Barracuda	383ci	
1969-70	Belvedere	383ci	
1969-71	Fury, Roadrunner, Satellite	383ci	
1969-71	All	426ci	

Performance Motor Mount

This re-engineered performance motor mount is firm enough for upgraded horsepower and torque, yet soft enough not to transmit excess vibration. Impervious to all under vehicle fluids. The set replaces right and left side mounts.

Year	Chrysler Models	Engine	Part No.
1983-89	Fifth Avenue	318	5.1106 2
1981-82	New Yorker, Cordoba, Imperial	318	
1977-81	Le Baron	318	
1975-79	Cordoba	318	
1975-77	Fifth Avenue, New Yorker, Imperial	318	
1980	Newport, New Yorker	360	
1975-79	All Car Models	360	
1974-78	All Car Models	400 & 440	

Year	Dodge Models	Engine	Part No.
1977-89	Diplomat	318	5.1106 2
1978-80	Aspen	318	
1979	Magnum XE	318	
1978	Monaco	318	
1974-77	All Models	318	
1973	Dart	318, 340	
1980	Aspen, Diplomat	360	
1979	Aspen, Diplomat, Magnum XE	360	
1978	Aspen, Diplomat, Monaco	360	



Performance Polyurethane Motor Mount Bushing Set Part Number 5.1106

Year	Dodge Models (cont.)	Engine	Part No.
1977	Aspen, Diplomat, Monaco	360	5.1106 2
1976	Dart, Aspen, Coronet, Monaco	360	
1974-75	Aspen, Monaco, Coronet	360	
1973-75	Dart	360	
1974-78	All Car Models	400, 440	

Year	Plymouth Models	Engine	Part No.
1980-89	Gran Fury	318	5.1106 2
1976-80	Fury, Volare	318	
1973-76	Duster, Valiant	318	
1974-75	Fury, Satellite	318	
1973-74	Duster, Valiant	340	
1976-80	Volare	360	
1975-80	Fury, Gran Fury	360	
1973-76	Duster, Valiant	360	
1974-78	Fury, Gran Fury	400, 440	

FOOTNOTES: 2 Must reuse existing outer metal shells

Note: For product color add R for red or G for black after each part number.

CHRYSLER - RWD (cont.)

Year	Front End Control Arm Bushing Set	Rear Leaf Spring Bushing Set	Body Mount Set	Front Strut Rod Bushing Set	Front Sway Bar Frame Bushings	Front End Links	Ball Joint Boot Set	Tie Rod Boots
------	-----------------------------------	------------------------------	----------------	-----------------------------	-------------------------------	-----------------	---------------------	---------------

A-BODY: DART, DEMON, DUSTER, VALIANT (BARRACUDA- Thru '69)

1973-76	5.3132 7	5.2105 5.2106 81		5.7109	¹³ / ₁₆ " 5.5112 ⁷ / ₈ " 5.5113 ¹⁵ / ₁₆ " 5.5115	9.8120	5.13102	9.13101 72
1962-72	5.3132 7	5.2105 5.2106 81		5.7105 63 5.7109 82	See Chart Below	9.8118 27	5.13102	9.13101 72
1966-76	Hyper-Flex® System Complete Master Set- See pg. 21			5.18104	1962-73	Upper Control Arm Bump Stop Set		9.9103
1962-76	Torsion Bar Dust Boot Set			5.13101	1962-76	Lower Control Arm Bump Stop Set		9.9119

B-BODY: CHARGER, CORONET, SATELLITE, GTX, ROADRUNNER, SUPERBEE

1973-79	5.3121 57	5.2110 114	5.4111 57	5.7109 30	¹³ / ₁₆ " 5.5136 ¹⁵ / ₁₆ " 5.5142		5.13102	9.13101 72	
1970-72	5.3132 7	5.2101 25 5.2104 26		5.7109	⁷ / ₈ " 5.5113 ¹⁵ / ₁₆ " 5.5115	9.8120	5.13102	9.13101 72	
1965-69	5.3132 7	5.2101 25 5.2104 26		5.7109	See Chart Below	9.8118	5.13102	9.13101 72	
1965-72	Hyper-Flex® System Complete Master Set- See pg. 21							5.18105	
1962-79	Torsion Bar Dust Boot Set			5.13101	1962-79	Upper Control Arm Bump Stop Set		9.9103	
1973-79	Torsion Bar Crossmember Mount Bushing Set			5.4110 57	1965-79	Lower Control Arm Bump Stop Set		9.9119	

A & B Body Front Sway Bar Bushing Sets

Choose to install the complete greaseable set with new adaptor brackets or bushings to fit into your stock sway bar brackets. Both feature our performance Hyper-Flex® polyurethane for handling and durability



Greaseable Bushing Adapter Kit

Year	Model	Greaseable Bushings & Adapters	O.E. style Sway Bar Bushings*
1967-72	"A" Body	⁷ / ₈ " 5.5134 ¹⁵ / ₁₆ " 5.5135	⁷ / ₈ " 5.5128 ¹⁵ / ₁₆ " 5.5129
1965-69	"B" Body	⁷ / ₈ " 5.5134 ¹⁵ / ₁₆ " 5.5135	⁷ / ₈ " 5.5128 ¹⁵ / ₁₆ " 5.5129

*Non-greaseable type. Reuses original brackets. Adapters not included.

E-BODY: BARRACUDA & CHALLENGER

1970-74	5.3132 7	5.2101 25 5.2104 26		5.7109	⁷ / ₈ " 5.5113 ¹⁵ / ₁₆ " 5.5115	9.8120	5.13102	9.13101 72
1970-74	Hyper-Flex® System Complete Master Set- See pg. 21			5.18105	1970-74	Lower Control Arm Bump Stop Set		9.9119
1970-74	Torsion Bar Dust Boot Set			5.13101 57	1970-74	Upper Control Arm Bump Stop Set		9.9103

Leaf Spring Pad Sets-

For Earlier Chrysler Cars

These Hyper-Flex® pad sets are far more durable than O.E.M. rubber pads. A must to use any time the rear leaf spring assembly is disassembled.



Year and Model	With Ribbed Sides	Without Ribbed Sides
1972-78 Full Size Chrysler and Imperial 1973-76 "B" Body: Charger, Coronet, Satellite, GTX, and Roadrunner (thru '75) 1973-76 "C" Body: Full Size Fury, Monaco and Polara (replaces O.E.M. part number 3402379)	5.6105	
1976-80 "F" Body: Volare, Aspen, Roadrunner and R/T 1980-83 "J" Body: Mirada, Cordoba to '89 (replaces O.E.M. part number 3815207)		5.6106

Performance Control Arm Bushings & Sway Bar Bushing Sets-

For F, J & M Bodies

Combine these Hyper-Flex® performance polyurethane bushing sets to get maximum performance and longevity.

Year and Model	Front Control Arm Bushing Set	Front Sway Bar Bushing Set
1976-80 Volare 1976-79 Aspen 1977-79 Diplomat 1980-83 Cordoba & Mirada 1977-81 Le Baron, Le Baron GTS, Limo 1982-89 Fifth Ave., Brougham, Newport, Gran Fury 1981-83 Imperial	5.3114 2	¹⁵ / ₁₆ " 5.5109 1" 5.5110 1 ¹ / ₈ " 5.5111

FOOTNOTES: 2 Must reuse existing outer metal shells 7 Uppers Only 25 With 2" Main eye except 426 and 440 models
26 With 1 1/2" Main eye 426 and 440 models 27 1965-72 30 1973-74 Only 57 Must reuse all metal parts 63 1962-65 only
72 Two boots per package- See page 13 for more information 81 All with 2" main eye & 5/8" bolt 82 1966 thru '72 only
114 With oval main eye bushing

Note: For product color add R for red or G for black after each part number.

Continued
Next Page



CARS

CHRYSLER - RWD (cont.)

Energy Suspension has strengthened the weak-links found in the suspension and drivetrain of today's iconic, modern muscle cars; the LX/LC chassis Charger and Challenger. Energy's polyurethane components offer greater stability, improved handling and more power to the rear wheels.



Year	Front End Control Arm Bushing Set	Front Sway Bar Frame Bushings	Steering Rack Bushing Set	Rear End Control Arm Bushing Set	Rear Sway Bar Bushing Set	Rear Differential Mount Bushing Set	Rear Sub-Frame Bushing Set
------	-----------------------------------	-------------------------------	---------------------------	----------------------------------	---------------------------	-------------------------------------	----------------------------

300C RWD

2005-10	5.3140 ^{2,140}	27mm 5.5170 30mm 5.5171 32mm 5.5172	5.10105	5.3141 ²	17.5mm 5.5173 ^{29,123}	5.1115 Fits 2005-14	5.4114 Fits 2005-14
---------	-------------------------	---	---------	---------------------	---------------------------------	------------------------	------------------------

CHALLENGER

NEW 2008-10	5.3140 ^{2,140}	27mm 5.5170 30mm 5.5171 32mm 5.5172	5.10105	5.3141 ²	17.5mm 5.5173 ^{29,123}	5.1115 Fits 2008-14	5.4114 Fits 2008-14
2011-14	Front Sway Bar Bushing Set - 28mm		5.5177	2011-14	Rear Sway Bar Bushing Set - 16mm		5.5178

CHARGER RWD

NEW 2006-10	5.3140 ^{2,140}	27mm 5.5170 30mm 5.5171 32mm 5.5172	5.10105	5.3141 ²	17.5mm 5.5173 ^{29,123}	5.1115 Fits 2006-14	5.4114
2011-14	Front Sway Bar Bushing Set - 28mm		5.5177	2011-14	Rear Sway Bar Bushing Set - 16mm		5.5178

MAGNUM RWD

2005-08	5.3140 ^{2,140}	27mm 5.5170 30mm 5.5171 32mm 5.5172	5.10105	5.3141 ²	17.5mm 5.5173 ^{29,123}	5.1115	5.4114
---------	-------------------------	---	---------	---------------------	---------------------------------	--------	--------

Year	Front End Control Arm Bushing Set	Rear End Control Arm Bushing Set	Body Mounts	Front Sway Bar Frame Bushings	Rear Sway Bar Frame Bushings	Tie Rod Boots	Ball Joint Boot Set
------	-----------------------------------	----------------------------------	-------------	-------------------------------	------------------------------	---------------	---------------------

VIPER

1996-02	5.3125 ⁵⁷	5.3126 ⁵⁷		1 1/16" 5.5138 ²⁹	7/8" 5.5139 ²⁹		
---------	----------------------	----------------------	--	------------------------------	---------------------------	--	--

PROWLER

1999-02	Hyper-Flex® System Suspension Set - Front control arm bushings, front and rear sway bar bushings						5.18113
---------	--	--	--	--	--	--	---------

CHRYSLER - FWD

Year	Front End Control Arm Bushing Set	Rear End Control Arm Bushing Set	Front Strut Rod Bushing Set	Front Sway Bar Frame Bushings	Front End Link Set	Rear Sway Bar Frame Set	Sub-Frame Mount Set	Tie Rod Boots
------	-----------------------------------	----------------------------------	-----------------------------	-------------------------------	--------------------	-------------------------	---------------------	---------------

AVENGER, SEBRING

1995-99				16mm 5.5133 19mm 5.5130		15mm 5.5146		
---------	--	--	--	----------------------------	--	-------------	--	--

EAGLE TALON, LASER- All Wheel Drive

1990-94	5.3108 ²³	5.3113		20mm 5.5106 ¹⁰⁴		20mm 5.5108 ¹⁰⁴	5.4105	9.13101 ⁷²
---------	----------------------	--------	--	----------------------------	--	----------------------------	--------	-----------------------

EAGLE TALON- FWD

1990-94	5.3108 ²³	5.3109					5.4103	9.13101 ⁷²
1990-94	Track Arm Bushing Set			5.7106				

LASER- FWD (All Wheel Drive, See EAGLE TALON)

1990-94	5.3108 ²³	5.3109		19mm 5.5107 ¹⁰⁴			5.4103	9.13101 ⁷²
1984-87	5.3107 ^{57 66}		5.7107 ¹³	1 1/8" 5.5105				9.13101
1990-94	Track Arm Bushing Set			5.7106				

FOOTNOTES: 2 Must reuse existing outer metal shells 13 Included in control arm bushing set 23 Front lowers must reuse existing outer shells 29 Greaseable frame bushings 57 Must reuse all metal parts 66 Includes strut bushings 72 2 Boots per package - See page 13 for more information 104 Sway bar end links included 123 Includes Sway Bar End Link Bushings 140 Includes tension/compression rod bushings

Note: For product color add R for red or G for black after each part number.

Continued
Next Page

CHRYSLER - FWD (cont.)



The **Hyper-Flex® System** Complete Master Set for Neons contains most part numbers below.



Neon Performance Polyurethane Motor & Transmission Mount Insert Set PN's 5.1107 & 5.1109

Year	Front End Control Arm Bushing Set	Rear End Control Arm Bushing Set	Rear Strut Rod Bushing Set	Front Sway Bar Frame Bushings	Front End Link Set	Rear Sway Bar Frame Set	Rear End Links	Tie Rod Boots
------	-----------------------------------	----------------------------------	----------------------------	-------------------------------	--------------------	-------------------------	----------------	---------------

NEON

2000-05	5.3123 57			20mm 5.5149	5.8105	14mm 5.5150	9.8124	
1995-99	5.3116 23	5.3117	5.7110	20mm 5.5144 22mm 5.5120	5.8101	16mm 5.5121 50	5.8102 50	9.13103 72
2000-05	Hyper-Flex® System Complete Master Set See pg. 21						5.18111	
1995-99	Hyper-Flex® System Complete Master Set- Including Sport Package Model. See pg. 21						5.18106	
2000-05	Rear Trailing Arm Bushings		5.7112		1995-99	Motor & Transmission Mount Insert Set		5.1107
2003-05	Motor Mount Insert Set 2.4L Only		5.1109					

SRT-4

2003-05	5.3129 57			24mm 5.5153	5.8107	17mm 5.5156	9.8119	
2003-05	Hyper-Flex® System Complete Master Set See pg. 21						5.18114	
2003-05	Motor Mount Insert Set - 2.4 Only		5.1109		2003-05	Rear Trailing Arm Bushing Set		5.7114
2003-05	Shifter Bushing Set		5.1110					

Year	Front End Control Arm Bushing Set	Rear End Control Arm Bushing Set	Front Strut Rod Bushing Set	Front Sway Bar Frame Bushings	Front End Link Set	Rear Sway Bar Frame Set	Rear End Links	Tie Rod Boots
------	-----------------------------------	----------------------------------	-----------------------------	-------------------------------	--------------------	-------------------------	----------------	---------------

PT CRUISER

2001-10	5.3129 57			24mm 5.5153	5.8105	16mm 5.5152 57		
2001-10	Hyper-Flex® System Complete Master Set- See pg. 21						5.18108	
2001-10	Rear Watts Link Bushing Set		5.8106		2001-10	Rear Trailing Arm Bushing Set		5.7113 57
2001-10	Rear Coil Spring Isolators		5.6110		2001-10	Lower Transmission Torque Mounts		5.1105
2001-10	Rear Bump Stop Set		5.6107 57					

FERRARI

Front and Rear Control Arm Bushing Assembly- (For Various Models.)

	Shell O.D. Measurement	O.E.M. Part #	Set * Number
*NOTE- One bushing per set.	30 mm	111616	13.3101
	34 mm	154539	13.3102

FOOTNOTES: 50 Sport Pkg. only 57 Must reuse all metal parts 72 2 Boots per package - See page 13 for more information

Note: For product color add R for red or G for black after each part number.

FORD

From the Ford Focus to the police-packaged equipped Crown Victoria, Energy's full line of re-engineered street and track tested performance polyurethane components enhance handling and control.



Ford Focus
PN's on Pg. 41

CARS

Year	Front End Control Arm Bushing Set	Rear End Control Arm Bushing Set	Rear Leaf Spring Bushing Set	Body Mount Set	Front Strut Rod Bushing Set	Front Sway Bar Frame Bushings	Front End Links	Tie Rod Boots
------	-----------------------------------	----------------------------------	------------------------------	----------------	-----------------------------	-------------------------------	-----------------	---------------

A C COBRA

1962-67	4.3125	4.3125					9.8120	
---------	--------	--------	--	--	--	--	--------	--

CONTOUR

1998-99		4.3154				20mm 4.5175		
---------	--	--------	--	--	--	-------------	--	--

1998-99	Motor Mount Inserts - (1 Torque Mount Position)		4.1107 ¹¹³	1998-99	Rear Sway Bar Bushings 18mm		4.5176	
---------	---	--	-----------------------	---------	-----------------------------	--	--------	--

CROWN VICTORIA

1998-02	4.3162 ^{57,110}							
1992-97	4.3150 ² 4.3153 ^{2,110}	4.3151 ²				1 1/8" 9.5170 1 3/16" 9.5171 1 1/4" 9.5172		
1972-78	4.3111 ²				4.7117	See page 7	9.8118	9.13101 ⁷²

1992-02	Complete Rear Sway Bar Bushing Set		17mm 4.5170 ¹⁰⁴ 21mm 4.5171 ¹⁰⁴	1998-02	Front Coil Spring Isolator Set		9.6101	
---------	------------------------------------	--	--	---------	--------------------------------	--	--------	--

ESCORT, ZX2

1997-01	4.3152					25mm 4.5168	9.8122	
1990-96						3/4" 4.5139 ¹⁰⁴		9.13101 ⁷²

1997-01	Hyper-Flex® System Complete Master Set- See pg. 22						4.18117	
---------	--	--	--	--	--	--	---------	--

1990-96	Rear Sway Bar Bushing Set Includes End Links 3/4" Dia.		4.5140	1997-01	Rear Trailing Arm Bushing		4.7123 ⁵⁷	
---------	--	--	--------	---------	---------------------------	--	----------------------	--

1997-01	Rear Sway Bar Bushing Set Includes End Links 13mm Dia.		4.5169	1997-01	Manual Transmission Shifter Stabilizer Bushing Set (trans side only)		4.1106	
---------	--	--	--------	---------	--	--	--------	--

1997-01	Rack and Pinion Bushing Set		4.10105	1997-01	Motor Mount Inserts- (2 Torque Mount Positions)		4.1105 ¹¹³	
---------	-----------------------------	--	---------	---------	---	--	-----------------------	--

FAIRMONT

1978-82	4.3132 ¹⁴	4.3114 ²				See page 7	9.8121	9.13101 ⁷²
---------	----------------------	---------------------	--	--	--	------------	--------	-----------------------

1978-84	Rack and Pinion Bushing Set		4.10102					
---------	-----------------------------	--	---------	--	--	--	--	--

FAIRLANE, GRAN TORINO, TORINO, ELITE, (RANCHERO after 3/15/72)

1972-79	4.3111 ²	4.3120 ²⁴			4.7117	See page 7	9.8118	9.13101 ⁷²
---------	---------------------	----------------------	--	--	--------	------------	--------	-----------------------

FAIRLANE, GRAN TORINO, TORINO, ELITE, RANCHERO

1967-71	4.3102 ^{2,18} 4.3106 ^{2,19}				4.7112	See page 7	9.8120	9.13101 ⁷²
---------	--	--	--	--	--------	------------	--------	-----------------------

FAIRLANE

1962-65	4.3131 ²		4.2141		4.7111	See page 7	See page 8	9.13101 ⁷²
---------	---------------------	--	--------	--	--------	------------	------------	-----------------------

FALCON, RANCHERO

1960-66	4.3101 ²				4.7111	See page 7	See page 8	9.13101 ⁷²
---------	---------------------	--	--	--	--------	------------	------------	-----------------------

FOOTNOTES: 2 Must reuse existing outer metal shells 14 Except heavy duty suspension 18 17/16" O.D. lower 19 19/16" O.D. lower 24 Uppers must reuse existing outer shells 57 Must reuse all metal parts 72 2 boots per package- see page 13 for more information 104 Sway bar end links included 110 Police, taxi, or tow package 113 With manual transmission

Note: For product color add R for red or G for black after each part number.

Continued
Next Page

ENERGYSUSPENSION.COM



F O R D (cont.)

Year	Front End Control Arm Bushing Set	Rear Trailing Arm Bushing Set	Motor Mount Torque Link Bushing Set	Front Sway Bar Frame Bushings	Rear Sway Bar Bushing Set	Rear Coil Spring Isolators	Rear Bump Stop Set
------	-----------------------------------	-------------------------------	-------------------------------------	-------------------------------	---------------------------	----------------------------	--------------------

FOCUS

2000-04	4.3156 2	4.7124 57		21mm 4.5178	20mm 4.5179 104	4.6105	
2000-04	Hyper-Flex® System Complete Master Set- See pg. 22						4.18119
2000-04	Motor Mount Bushing (Lower Rear Torque Position Only)		4.1123 57				

Year	Front End Control Arm Bushing Set	Rear End Control Arm Bushing Set	Rear Leaf Spring Bushing Set	Body Mount Set	Front Strut Rod Bushing Set	Front Sway Bar Frame Bushings	Front End Links	Tie Rod Boots
------	-----------------------------------	----------------------------------	------------------------------	----------------	-----------------------------	-------------------------------	-----------------	---------------

FULL SIZE FORD, GALAXIE, CUSTOM, LTD (thru '82), Except Police Car

1972-78	4.3111 2				4.7117	See page 7	9.8118	9.13101 72
1965-71					4.7117			

GRANADA

1981-82	4.3132 14	4.3114 2				See page 7	9.8121	9.13101 72
1975-80	4.3102 2,18 4.3106 2,19				4.7112	See page 7	9.8120	9.13101 72
1981-82	Rack and Pinion Bushing Set		4.10102	1981-86	Transmission Mount 4 Cyl - All Trans		4.1104	

MAVERICK

1970-77	4.3102 2,18 4.3106 2,19					See page 7	9.8117	9.13101 72
---------	----------------------------	--	--	--	--	------------	--------	------------

MERCURY

	Early Ford / Mercury Mount Set		4.1135		Motor / Transmission Mount Set		4.1137
	Early Ford / Mercury Transmission Mount		4.1136				

PINTO

1974-80	4.3130				4.7113	See page 7		9.13101 72
1976-80	Rack and Pinion Bushing Set		4.10102	1974-3/76	Rack and Pinion Bushing Set		4.10101	

TAURUS

1986-95					4.7119	See page 7		9.13101 72
1986-95	Rear Strut Rod Bushing Set-Sedan Only		4.7120	1986-95	Rear Sway Bar Bushing Set-(sedan only)		1 1/16" 4.5132	

THUNDERBIRD

1989-97		See Below				1 1/16" 4.5137		9.13101 72
1987-88	4.3123 2	4.3114 2,6 4.3115 2,1				See Chart Page 43	9.8119	9.13101 72
1980-86	4.3132 14	4.3114 2,6 4.3115 2,1				See Chart Page 43	9.8121 16 9.8119 17	9.13101 72
1975-79	4.3111 2				4.7117	See page 7	9.8118	9.13101 72
1972-74	4.3111 2	4.3120 24			4.7117	See page 7	9.8118	9.13101 72
1990-97	Complete Rear Sway Bar Bushing Set		1 1/16" 4.5138	1983-88	Ball Joint Dust Boot Set		9.13130	
1989-97	Differential Carrier Bushings		4.1126	10/1984-88	Rack and Pinion Bushing Set		4.10103	
1989-97	Rear Control Arm Bushing - Spindle Position Only		4.3163	1980-9/84	Rack and Pinion Bushing Set		4.10102	

See Page 18 for Thunderbird Motor and Transmission mounts

FOOTNOTES: 1 With oval front bushing 2 Must reuse existing outer metal shells 6 With all round bushings
 14 Except heavy duty suspension 16 '80-82 17 '83-87 18 1 7/16" O.D. lower 19 1 9/16" O.D. lower
 24 Uppers must reuse existing outer shells 57 Must reuse all metal parts 72 2 boots per package- see page 13 for more information
 104 Sway bar end links included

Note: For product color add R for red or G for black after each part number.



FORD - MUSTANG

CARS



Far greater than factory rubber bushings, Energy's Hyper-Flex® polyurethane components can tame your Mustang on the street and track. More compliant than solid bushing and mounts yet firmer to improve rear handling and reduce wheel hop. Made in the USA.

Hyper-Flex® System Master Set for Late-Model Mustangs contains most part numbers below.

Year	Front End Control Arm Bushing Set	Rear End Control Arm Bushing Set	Rear Track Arm Bushing	Front Sway Bar Frame Bushings	Rear Sway Bar Frame Bushings	Rear Differential Mount Set	Sub-Frame Bushing Set	Front Ball Joint Boot Set
------	-----------------------------------	----------------------------------	------------------------	-------------------------------	------------------------------	-----------------------------	-----------------------	---------------------------

MUSTANG

NEW 2015-16	4.3170 ¹⁵⁶	4.3166 ¹⁴⁸		33.3mm 4.5200 32mm 4.5199	22mm 4.5198	4.1139	4.4122	
NEW 2011-14	4.3165 ^{2,57}	4.3169 ^{7,24}		35mm 9.5187 ²⁹	24mm 4.5195 ¹²³			
2005-10	4.3165 ^{2,57}	4.3167 ^{7,24}	4.7129	34mm 4.5193	20mm 4.5191 ¹²³			
2011-14	Trans Mount / Shift Bushing Set			4.1140 ^{57,113}	2005-10	Manual Transmission Shifter Stabilizer Bushing Set		4.1131 ⁵⁷
2011-14	Shifter Bushing			4.1134 ⁵⁷	2015-16	Shifter Bushing		4.1145 ^{57,113}
2011-16	Trans Mount Insert Set with MT-82 Trans			4.1138	2015-16	Trans Mount / Shift Bushing Set		4.1141 ^{57,113}
NEW 2015-16	Hyper-Flex® System Complete Master Set- See pg. 21						4.18127 ^{95,148,156}	

Year	Front End Control Arm Bushing Set	Rear End Control Arm Bushing Set	Rear Track Arm Bushing	Front Sway Bar Frame Bushings	Rear Sway Bar Frame Bushings	Rear Differential Mount Set	Sub-Frame Bushing Set	Front Ball Joint Boot Set
------	-----------------------------------	----------------------------------	------------------------	-------------------------------	------------------------------	-----------------------------	-----------------------	---------------------------

1999-04	Hyper-Flex® System Complete Master Set- See pg. 21						4.18121 ^{95,148,156}	
1994-98	Hyper-Flex® System Complete Master Set- See pg. 21						4.18112	
1994-95	Hyper-Flex® System Complete Master Set- w/ V-8 Includes transmission mount. See pg. 21						4.18109	
1985-93	Hyper-Flex® System Complete Master Set- w/ V-8 Includes transmission mount. See pg. 21						4.18110	
1985-93	Hyper-Flex® System Complete Master Set- See pg. 21						4.18113	
1999-04	4.3144	4.3155 ^{2,95}		See Page 43		9.8124	9.13101 ⁷²	9.13130
1999-04	Rear Sub-Frame Bushing Set			4.4116 ²	1999-04	Differential Carrier Bushing Set (Without Dampener Installed)		4.1126
1979-04	Rear Spring Upper & Lower Isolators			4.6101 ⁹⁵	1983-04	Front Spring Upper & Lower Isolators		4.6102
10/1984-04	Rack and Pinion Bushing Set			4.10103	1979-93	Transmission Crossmember Mount To Frame Bushing		4.1102
10/1984-04	Offset Rack & Pinion Bushing Set Recommended For Lowered Vehicles Only			4.10104	1983-04	McPherson Strut Tower Bushing Set		4.7114
1979-9/84	Rack and Pinion Bushing Set			4.10102	1983-98	Front Strut Bumpstop		4.6103
1999-04	4.3144	4.3155 ^{2,95}		See Page 43		9.8124	9.13101 ⁷²	9.13130
1994-98	4.3144	4.3115 ²		See Page 43		9.8124	9.13101 ⁷²	9.13130
1983-93	4.3132	4.3114 ^{2,6} 4.3115 ^{2,1}		See Page 43		9.8121	9.13101 ⁷²	9.13130
1979-82	4.3132 ¹⁴	4.3114 ^{2,6} 4.3115 ^{2,1}		See Page 43		9.8121	9.13101 ⁷²	9.13130

MUSTANG COBRA

1999-04	4.3144	4.3161 ⁵⁷		See Page 43		9.8124	9.13101 ⁷²	9.13130
---------	--------	----------------------	--	-------------	--	--------	-----------------------	---------

FOOTNOTES: 1 With oval front bushing 2 Must reuse existing outer metal shells 6 With all round bushings 7 Uppers Only
 14 Except heavy duty suspension 24 Uppers must reuse existing outer shells 29 Greaseable Frame Bushings 57 Must reuse all metal parts
 72 2 boots per package- See page 13 for more information 95 Except Cobra with I.R.S. 113 With manual transmission
 123 Includes sway bar end link bushings 148 Must remove factory metal shells 156 Lower, front position only

Note: For product color add R for red or G for black after each part number.

Continued
Next Page

ENERGYSUSPENSION.COM



FORD - MUSTANG (cont.)

Mustang 1979-04 OEM Style Front Sway Bar Bushing Set

(ALSO FITS 1980-88 THUNDERBIRD, COUGAR and 1979-86 CAPRI)

These bushings deliver all of the performance and durability you

demand from Hyper-Flex® performance polyurethane components.



Bar Diameter	O.E. Style (reuse factory brackets) 1979-02	Greaseable Bushings Includes Base Plate (reuse outer bracket) 1979-93 1994-04	
7/8"	4.5113		
15/16"	4.5112		
1"	4.5111		
1 1/16" 27mm	4.5110	4.5158	4.5166
1 1/8" 28mm	4.5109	4.5159	4.5174
30mm	4.5135		4.5167
1 1/4"	4.5108	4.5161	
15/16"	4.5101	4.5162	
1 3/8"	4.5136	4.5163	

Year	Front End Control Arm Bushing Set	Rear End Control Arm Bushing Set	Rear Leaf Spring Bushing Set	Front Strut Rod Bushing Set	Front Sway Bar Frame Bushings	Front End Links	Tie Rod Boots	Front Ball Joint Boot Set
1974-78	4.3130			4.7113	See Page 7		9.13101 72	
1967-73	4.3102 2,18 4.3106 2,19		4.2101	4.7112	See Page 7	9.8117	9.13101 72	
1964-66	4.3101 2,8		4.2101 35	4.7111	See Page 7	9.8120	9.13103 72	
1967-73	Hyper-Flex® System Complete Master Set- See pg. 22			4.18111	1974-78	Rack and Pinion Bushing Set		4.10101

Mustang Heavy Duty Shackle Sets

Get improved handling and control with these Hyper-Flex® performance shackle sets.

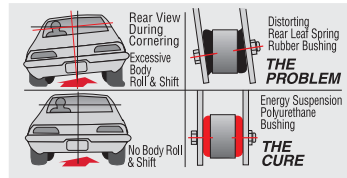

1964-73	Includes All Spring Bushings, Shackle Bushings and Hardware	4.2135
1964-73	Shackle Bushings and Hardware Only	4.2136

HONDA

Motor Mount Inserts

To be used in conjunction with the original stock motor mount. Engineered to provide improved performance by eliminating excess engine movement. This unwanted movement results in wheel hop, due to inferior stock rubber motor mounts.

The benefit of this insert design is additional strength and toughness, thanks to Hyper-Flex® polyurethane support for the existing rubber part. This solution is quick and easy to install. It's just as simple to remove and return the mount to stock configuration, if so desired.



Year	Model With Manual Transmission	No. Of Positions Supplied *	Set #
1994-97	Accord	1	16.1108
1990-93	Accord	1	16.1107
2002-05	Civic Si	2	16.1110
1999-00	Civic Si	3	16.1106
2001-05	Civic	2	16.1111
1992-00	Civic	3	16.1105
1988-91	Civic	2	16.1104
1993-97	Del Sol	3	16.1105
1992-01	Prelude	2	16.1103

* Only torque positions supplied

Year	Front End Control Arm Bushing Set	Rear End Control Arm Bushing Set	Front Strut Rod Bushing Set	Front Sway Bar Frame Bushings	Rear Sway Bar Frame Bushings	Front End Links	Tie Rod Boots	Front Ball Joint Boot Set	
ACCORD & ODYSSEY									
1994-97	16.3106		16.7103	25mm 9.5129 22mm 9.5126	15mm 16.5117 14mm 16.5116	16.8105	9.13103 72	16.13102	
1990-93	16.3110		16.7103	25mm 9.5129	14mm 16.5116 13mm 16.5107	16.8105	9.13103 72	16.13102	
1994-97	Hyper-Flex® System Complete Master Set- See pg. 23							16.18107	
1990-93	Hyper-Flex® System Complete Master Set- See pg. 23							16.18108	
1990-97	Front Coil Spring Isolator		16.6101		1990-97	Front Shock Upper & Lower Bushing Set		16.8106	
					1990-93	Rear Ball Joint Boot Set		9.13103	

FOOTNOTES: 2 Must reuse existing outer metal shells 8 Lowers only 18 17/16" O.D. lower 19 19/16" O.D. lower 35 Fits 1/2" Shackle Bolts- 9/16" use 4.2123 72 2 boots per package- See page 13 for more information

Note: For product color add R for red or G for black after each part number.



H O N D A (cont.)

Year	Front End Control Arm Bushing Set	Rear End Control Arm Bushing Set	Front Strut Rod Bushing Set	Front Sway Bar Frame Bushings	Rear Sway Bar Frame Bushings	Front End Links	Tie Rod Boots	Front Ball Joint Boot Set
------	-----------------------------------	----------------------------------	-----------------------------	-------------------------------	------------------------------	-----------------	---------------	---------------------------

CIVIC & CRX 1992-05 (1999-2011 Civic Si - See Below)

2001-05	16.3116	16.3118 lower only		16mm 16.5136 1" 16.5133	12mm 16.5135				
1996-00	16.3114			22mm 16.5121		16.8104	9.13103 72	16.13101	
1992-95	16.3105	16.3104 lower only		24mm 16.5104 22mm 16.5108 21mm 16.5105	15mm 16.5117 13mm 16.5107	16.8104	9.13103 72	16.13101	
1996-00	Hyper-Flex® System Complete Master Set- See pg. 23						16.18110		
1992-95	Hyper-Flex® System Complete Master Set- See pg. 23						16.18103		
1996-00	Front Coil Spring Isolators		16.6104		1992-00	Rear Trailing Arm Bushing Set		16.7106 57	
1996-00	Rear Coil Spring Isolators		16.6103		1992-00	Front Shock Upper & Lower Bushing Set		16.8102	
1996-00	Steering Rack Bushing Set (Power Steering Only)		16.10104		1992-95	Rear Shock Upper & Lower Bushing Set		16.8103	
1992-95	Steering Rack Bushing Set (Power Steering Only)		16.10102		1992-00	Manual Transmission Shifter Stabilizer Bushing Set		16.1102	

Transmission shifter bushings assure more positive shifting under all conditions. Hyper-Flex® material last longer than O.E.M. rubber bushings.



Re-engineered Rear Trailing Arm Bushings dramatically help the vehicle maintain proper rear toe and caster under high performance driving conditions. Important when using larger than stock tires and wheels.



Year	Front End Control Arm Bushing Set	Rear End Control Arm Bushing Set	Front Strut Rod Bushing Set	Front Sway Bar Frame Bushings	Rear Sway Bar Frame Bushings	Front End Links	Tie Rod Boots	Front Ball Joint Boot Set
------	-----------------------------------	----------------------------------	-----------------------------	-------------------------------	------------------------------	-----------------	---------------	---------------------------

CIVIC & CRX 1984-91

1988-91	16.3103	16.3104 85 lower only 16.3111 119 lower only	16.7102	19mm 16.5111 18mm 16.5110 16mm 16.5109	15mm 16.5112	16.8104	9.13103 72	16.13101	
1988-91	Hyper-Flex® System Complete Master Set- See pg. 23						16.18102		
1988-91	Steering Rack Bushing Set (Power Steering Only)		16.10101		1988-91	Rear Trailing Arm Bushing Set		16.7106 57	
1988-91	Front Shock Upper & Lower Bushing Set		16.8102		1988-91	Manual Transmission Shifter Stabilizer Bushing Set		16.1102	
1989-91	Rear Shock Upper & Lower Bushing Set		16.8103						
1984-87	16.3101	16.3102 49		18mm 16.5120 104 16mm 16.5101 104			9.13103 72	9.13101 72	
1984-87	Hyper-Flex® System Complete Master Set- See pg. 23						16.18101		
1984-87	Rear End Links		16.5102		1984-87	Manual Transmission Shifter Stabilizer Bushing Set		16.1101	

CIVIC Si

NEW 2006-11	16.3122 148	16.3123 3,8		27mm 16.5148 28mm 16.5146	17mm 16.5147				
NEW 2006-11	Hyper-Flex® System Complete Master Bushing Set						16.18114		
2006-11	Rear Upper Shock Bushing Set		16.8112 7,57		2006-11	Rack & Pinion Bushing Set		16.10105	
2002-05	16.3116	16.3118		1" 16.5133	15mm 16.5134				
2002-05	Hyper-Flex® System Complete Master Set- See pg. 23						16.18112		
1999-00	16.3115			26mm 16.5130	15mm 16.5134 13mm 16.5107				
1999-00	Hyper-Flex® System Complete Master Set- See pg. 23						16.18109		
1999-00	Front Shock Bushing Set		16.8111		1999-00	Rear Coil Spring Isolators		16.6103	
1999-00	Steering Rack Bushing Set (Power Steering Only)		16.10104		1999-00	Rear Trailing Arm Bushing Set		16.7106 57	
1999-00	Front Coil Spring Isolators		16.6104		1999-00	Manual Transmission Shifter Stabilizer Bushing Set		16.1101	

FOOTNOTES: 3 Lower must use existing outer metal shells 7 Uppers only 8 Lower only 49 Includes trailing arm bushings 57 Must reuse all metal parts 72 2 boots per package- See pg. 13 for more info. 85 1989 thru '91 only 104 Sway bar end links included 119 1988 only 148 Must remove factory metal shells

Note: For product color add R for red or G for black after each part number.

H O N D A (cont.)



Hondas have amazing horsepower potential which must be backed up by the chassis and drivetrain for proper vehicle handling. **Energy Suspension's** components are engineered for control engine upgrades and putting the power to the ground.

Year	Front End Control Arm Bushing Set	Rear End Control Arm Bushing Set	Front Strut Rod Bushing Set	Front Sway Bar Frame Bushings	Rear Sway Bar Frame Bushings	Front End Links	Tie Rod Boots	Front Ball Joint Boot Set
------	-----------------------------------	----------------------------------	-----------------------------	-------------------------------	------------------------------	-----------------	---------------	---------------------------

Motor Mount Inserts - See Page 43

DEL SOL- including VTEC

1993-97	16.3105	16.3104 lower only		24mm 16.5104 22mm 16.5108 21mm 16.5105	15mm 16.5117 13mm 16.5107	16.8104 70	9.13103 72	16.13101
1993-97	Hyper-Flex® System Complete Master Set- See pg. 23							16.18103
1993-97	Front Shock Upper & Lower Bushing Set		16.8102	1993-97 Rear Trailing Arm Bushing Set		16.7106 57		
1993-97	Rear Shock Upper & Lower Bushing Set		16.8103	1993-97 Manual Transmission Shifter Stabilizer Bushing Set (VTEC Only)		16.1101		
1993-97	Steering Rack Bushing Set (Power Steering Only)		16.10102	1993-97 Manual Transmission Shifter Stabilizer Bushing Set (Except VTEC)		16.1102		

Motor Mount Inserts - See Page 43

PRELUDE

1997-01	16.3119 (Type SH Only)	16.3112	16.7108 (Type SH Only)	25mm 16.5123 104	23mm 16.5122 104			
1992-96	16.3106	16.3112	16.7103	25mm 16.5123 104	23mm 16.5122 104			
1997-01	Hyper-Flex® System TYPE SH ONLY Complete Master Set- See pg. 23							16.18113
1992-96	Hyper-Flex® System Complete Master Set- See pg. 23							16.18106
1992-01	Rear Trailing Arm Bushing Set		16.7105	1992-01 Rear Bump Stop Set		16.9102		
1992-01	Front Coil Spring Isolator Set		16.6101	1992-01 Front Shock Upper & Lower Bushing Set		16.8106		
1992-01	Rear Coil Spring Isolator Set		16.6103	1992-01 Rear Shock Upper & Lower Bushing Set		16.8108		
1992-01	Front Bump Stop Set		16.9101					

Motor Mount Inserts - See Page 43

S2000 (AP1 / AP2)



2000-09	16.3120 3	16.3121 3		26.5mm 16.5140 27.2mm 16.5141 28.2mm 16.5139 28.6mm 16.5142	25.4mm 16.5144 26.5mm 16.5145 27.2mm 16.5143		9.13103 72	
2000-09	Rear Differential Carrier Bushing Set		16.1112 2					

I N F I N I T I

Year	Front End Control Arm Bushing Set	Rear End Control Arm Bushing Set	Front Tension Rod Bushing	Front Sway Bar Frame Bushings	Front End Links	Rear Sway Bar Frame Bushings	Rear Differential Carrier Bushing Set	Tie Rod Boots
------	-----------------------------------	----------------------------------	---------------------------	-------------------------------	-----------------	------------------------------	---------------------------------------	---------------

G-35 COUPE RWD

2003-07	7.3121 140	7.3122		32mm 7.5126		21mm 7.5127	7.1119	
2003-07	Hyper-Flex® System Complete Master Set- See pg. 23							7.18108
2003-07	Rear Sub Frame Set		7.4103	2003-04 Steering Rack Bushings		7.10105		

FOOTNOTES: 2 Must reuse existing outer metal shell 3 Lowers must use existing outer metal shells 57 Must reuse all metal parts 70 GSR & Del Sol VTEC will use one half of the set 72 2 Boots per package - See page 13 for more information 104 Sway bar end links included 140 Includes Tension / Compression Rod / Strut

Note: For product color add R for red or G for black after each part number.



LINCOLN & MERCURY

Year	Front End Control Arm Bushing Set	Rear End Control Arm Bushing Set	Rear Leaf Spring Bushing Set	Body Mount Set	Front Strut Rod Bushing Set	Front Sway Bar Frame Bushings	Front End Links	Tie Rod Boots
------	-----------------------------------	----------------------------------	------------------------------	----------------	-----------------------------	-------------------------------	-----------------	---------------

CAPRI

1979-86	4.3132 14	4.3114 2,6 4.3115 2,1				See Chart Page 43	9.8121	9.13101 72
1979-86	Rack and Pinion Bushing Set (before 10-1-84 use 4.10102, after use 4.10103)		4.10102 4.10103		1979-84	Transmission Mount 8 Cyl. (all transmissions)		4.1104
1979-86	Ball Joint Dust Boot Set		9.13130		1980-84	Transmission Mount 6 Cyl. (all transmissions)		4.1104
1979-86	Transmission Mount 4 Cyl. (all transmissions)		4.1104					

COMET

1966-77	4.3102 2,18				4.7112	See page 7	9.8120	9.13101 72
1961-65	4.3106 2,19 4.3101 2				4.7111	See page 7	9.8122	9.13103 72

COUGAR 1967-72 see pg 18 for motor mount applications

1999-01		4.3154				20mm 4.5175		
1989-97						1 1/16" 4.5137		9.13101 72
1987-88	4.3123 2	4.3114 2,6 4.3115 2,1				See Chart Page 43	9.8119	9.13101 72
1980-86	4.3132 14	4.3114 2,6 4.3115 2,1				See Chart Page 43	9.8121	9.13101 72
1974-79	4.3111 2				4.7117	See page 7	9.8118	9.13101 72
1967-73	4.3102 2,18 4.3106 2,19				4.7112	See page 7	9.8117	9.13101 72

1990-97	Complete Rear Sway Bar Bushing Set 1 1/16" Bar Diameter		4.5138 123		1980-86	Ball Joint Dust Boot Set		9.13130
1985-88	Rack and Pinion Bushing Set		4.10103		1999-01	Rear Sway Bar Bushing Set 18mm		4.5176 123
1980-82	Motor Mount Set for 5.0 (302ci) See page 40 for more info.		4.1122		1999-00	Motor Mount Insert (1 Torque Mount Position) See Pg. 5		4.1107 113
					1980-82	Transmission Mount 6 and 8 Cyl. (all transmissions)		4.1104

GRAND MARQUIS

1998-02	4.3162 57,110					1 1/8" 9.5170		
1992-97	4.3150 2 4.3153 2,110	4.3151 2				1 3/16" 9.5171 1 1/4" 9.5172		
1992-97	Complete Rear Sway Bar Bushing Set		17mm 4.5170 21mm 4.5171					

LINCOLN CONTINENTAL, MK III, IV, V

1973-79	4.3111 2				4.7117 112			9.13101 72
1961-69	4.3122 2,8				4.7118	See page 7	See page 8	9.13101 72
1982-87	Motor Mount Set for Continental with 5.0 V8 (302 ci)		4.1122		1984-92	Motor Mount Set for Mark Series with 5.0 V8 (302 ci)		4.1122

M A Z D A

Year	Front End Control Arm Bushing Set	Rear End Control Arm Bushing Set	Front Strut Rod Bushing Set	Front Sway Bar Bushings	Rear Sway Bar Bushings	Front End Links	Tie Rod Boots	Front Ball Joint Boot Set
------	-----------------------------------	----------------------------------	-----------------------------	-------------------------	------------------------	-----------------	---------------	---------------------------

626, MX6

1988-92				18mm 9.5122		9.8106	9.13105 72	
1979-82	11.3101					9.8123		

RX7

1993-95				28mm 11.5108	16mm 11.5109				
1989-91	11.3102	11.3103		24mm 11.5104	14mm 11.5105		9.13103 72	9.13105	
1986-88	11.3102	11.3103		24mm 11.5104	14mm 11.5105	9.8134 Front or Rear	9.13103 72	9.13105	
1979-85	11.3101 2	11.3104	11.7101	23mm 11.5101	14mm 11.5106	9.8123 Front or Rear	9.13105 72	9.13105	
1986-91	Hyper-Flex® System Complete Master Set- See pg. 23							11.18101	

1993-95	Rear Trailing Arm Bushing Set	11.7103	1979-85	Rear Watts Link Set	11.7102
---------	-------------------------------	---------	---------	---------------------	---------

RX8

2004-07	11.3107	11.3108		11.5110	11.5111			
---------	---------	---------	--	---------	---------	--	--	--

FOOTNOTES: 1 With oval front bushing 2 Must reuse existing outer metal shells 6 With all round bushings 8 Lower only
 14 Except heavy duty suspension 18 17/16" O.D. lower 19 19/16" O.D. lower
 57 Must reuse all metal parts 72 2 boots per package- See page 13 for more information 110 Police, taxi, or tow package
 112 Except MKIII & IV 113 With manual transmission 123 Includes sway bar end link bushings.

Note: For product color add R for red or G for black after each part number.



M A Z D A (cont.)

Year	Front End Control Arm Bushing Set	Rear End Control Arm Bushing Set	Front Strut Rod Bushing Set	Front Sway Bar Bushings	Rear Sway Bar Bushings	Front End Links	Tie Rod Boots	Front Ball Joint Boot Set
------	-----------------------------------	----------------------------------	-----------------------------	-------------------------	------------------------	-----------------	---------------	---------------------------

MX-5 MIATA (ND)

NEW 2016+	11.3111 148	11.3112 148		22mm 11.5116	11mm 11.5117			
2016+	Differential Carrier Bushing Set		11.1102 148					
2016 +	Hyper-Flex® System Complete Bushing Master Set- See pg. 23						11.18105	

MX-5 MIATA (NC)

NEW 2006-14	11.3109 148	11.3110		21mm 11.5114	11mm 11.5115			
2006-14	Differential Carrier Set		11.1101	2006-14	Rack & Pinion Bushing Set		11.10101	
2006-14	Hyper-Flex® System Complete Bushing Master Set - See pg. 23						11.18104	

MX-5 MIATA (NB)

1999-05	11.3105		11.3106	9.5124	20mm	12.5mm 11.5103		
1999-05	Rear Differential Mount		11.4101					

MX-5 MIATA (NA)

1990-97	11.3105	11.3106		19mm 11.5102 123	12.5mm 11.5103 123			
1990-97	Hyper-Flex® System Complete Master Set- See pg. 23						11.18102	
1990-97	Rear Differential Bushings		11.4101					

MITSUBISHI Energy Suspension is well aware of Mitsubishi enthusiasts' wants and needs, and recognizes that these platforms have become a popular choice with the performance street set, hard-core racers and the show crowd.

Year	Front End Control Arm Bushing Set	Rear End Control Arm Bushing Set	Sub-Frame Bushing Set	Front Sway Bar Frame Bushings	Rear Sway Bar Frame Bushings	Tie Rod Boots	Front Ball Joint Boot Sets
------	-----------------------------------	----------------------------------	-----------------------	-------------------------------	------------------------------	---------------	----------------------------

ECLIPSE- Front Wheel Drive

2006-07	5.3138			22mm 5.5161 21mm 5.5163	20mm 5.5162			
Feb 2001-04	5.3136	5.3128			18mm 9.5122 19mm 9.5123			
2000-01/Jan	5.3127	5.3128		16mm 5.5151	18mm 9.5122 19mm 9.5123			
1995-99	5.3118	5.3119		16mm 5.5133 18mm 5.5132 19mm 5.5130	12mm 5.5145 15mm 5.5146 18mm 5.5147			
1990-94	5.3108 23	5.3109	5.4103			9.13101 72		
2000-01/ Jan	Hyper-Flex® System Complete Master Set- See pg. 23						5.18110	
1995-99	Hyper-Flex® System Complete Master Set- See pg. 23						5.18107	
2006-07	Rear Trailing Arm Bushing Set		5.7115	1995-99	Rear Shock Upper Bushing Set		5.8104	
1995-99	Front Shock Upper Bushing Set		5.8103	1990-94	Rear Track Arm Bushing Set		5.7106	
1995-99	Motor Mount Inserts- (2 torque mount positions only) See pg. 5.		5.1103 113	1995-04	Manual Transmission Shifter Stabilizer Bushing Set		5.1102	
2006-07	Motor Mount Replacements with V-6 (2 torque mount positions only)		5.1113 57	2006-07	Manual Transmission Shifter Stabilizer Bushing Set		5.1111	
2000-04	Motor Mount Inserts- (2 torque mount positions only) See pg. 5.		5.1104 121					

ECLIPSE- All Wheel Drive

1995-99	5.3118	5.3119		16mm 5.5133 18mm 5.5132 19mm 5.5130	12mm 5.5145 15mm 5.5146 18mm 5.5147			
1990-94	5.3108 23	5.3113	5.4105	20mm 5.5106 104	20mm 5.5108 104	9.13101 72		
1995-99	Hyper-Flex® System Complete Master Set- See pg. 23						5.18107	
1995-99	Motor Mount Inserts- (2 torque mount positions only) See pg. 5.		5.1103 113	1995-99	Front Shock Upper Bushing Set		5.8103	
1995-01	Manual Transmission Shifter Stabilizer Bushing Set		5.1102	1995-99	Rear Shock Upper Bushing Set		5.8104	

LANCER EVOLUTION VIII

2003-05	5.3133			24mm 5.5157	22mm 5.5155			
2003-05	Hyper-Flex® System Complete Master Set- See pg. 23						5.18115	
2003-05	Rear Trailing Arm Bushing Set		5.3134	2003-05	Rear Differential Set		5.1108	

FOOTNOTES: 23 Front lowers must reuse existing outer shells 57 Must reuse all metal parts 72 Two boots per package- see page 13 for more information 104 Sway bar end links included 113 With manual transmission 121 V6 engine only 123 Includes sway bar end link bushings. 148 Remove factory shells

Note: For product color add R for red or G for black after each part number.

M G

Year	Front End Control Arm Bushing Set	Rear End Control Arm Bushing Set	Rear Leaf Spring Bushing Set	Body Mount Set	Front Strut Rod Bushing Set	Front Sway Bar Frame Bushings	Front End Links	Tie Rod Boots
------	-----------------------------------	----------------------------------	------------------------------	----------------	-----------------------------	-------------------------------	-----------------	---------------

MGB

1974 ^{1/2} -80	10.3102		10.2101			5/8" 10.5102	10.8101	9.13103 72
1962-74 ^{1/2}	10.3102		10.2101			9/16" 10.5101	10.8101	9.13103 72
1977-80	Rear Sway Bar Bushing Set 11/16"		10.5103		1962-80	Rear Bump Stop Set		10.6101
1977-80	Rear Sway Bar End Link Set		10.8102		1962-80	Transmission Buffer Mount Set		10.1101
1962-80	Rear Leaf Spring Pad Set		10.6102					

NISSAN / DATSUN



Year	Front End Control Arm Bushing Set	Rear End Control Arm Bushing Set	Front Tension Strut Rod Bushing Set	Front Sway Bar Frame Bushings	Front End Links	Rear Sway Bar Frame Bushings	Rear Differential Carrier Bushing Set	Tie Rod Boots
------	-----------------------------------	----------------------------------	-------------------------------------	-------------------------------	-----------------	------------------------------	---------------------------------------	---------------

240, 260, 280, "Z" CARS

1970-78	7.3106 8	7.3104	7.7102	16mm 7.5112 18mm 7.5101 20mm 7.5102 21mm 7.5103	9.8120			9.13103 72
1974-78	260Z, 280Z Hyper-Flex® System Complete Master Set- See pg. 23							7.18102
1970-73	240Z Hyper-Flex® System Complete Master Set- See pg. 23							7.18101
1974-78	260, 280Z Rear Sway Bar Bushings (20mm)		7.5110		1970-78	Front and Rear McPherson Strut Bump Stop Set		7.6104
1974-78	260, 280Z End Link Bushing Set (rear)		9.8120		1970-78	Transmission Crossmember Mount Bushing		7.1101
1970-78	Steering Coupler		7.16101		1970-78	Differential Carrier "Mustache Bar" Bushings		7.1102
1970-78	240Z Rack and Pinion Bushing Set		7.10101					
1974-78	260, 280Z Rack and Pinion Bushing Set		7.10102					

240SX

1995-98	7.3108 2	7.3119	7.7105	27mm 7.5114 104		16mm 7.5113 104	7.1118 57	9.13103 72
1995-98	Hyper-Flex® System Complete Master Set- See pg. 23							7.18107
1995-98	Rear Subframe Set		7.1117 2 57		1995-98	Steering Rack Bushings (w/power steering only)		7.10104
1989-94	7.3114	7.3115	7.7105	24mm 7.5121 123 25mm 7.5123 123		15mm 7.5122 123		
1989-94	Hyper-Flex® System Complete Master Set- See pg. 23							7.18106
1989-94	Rear Subframe Insert Set		7.1113 2 57		1989-94	Steering Rack Bushings (w/power steering only)		7.10104

280ZX

1979-83	7.3103 8	7.3105	7.7102	22mm 7.5111 23mm 7.5104	9.8122	20mm 7.5110		9.13103 72
---------	----------	--------	--------	----------------------------	--------	-------------	--	------------

FOOTNOTES: 2 Must reuse existing outer metal shells 8 Lower only 57 Must reuse all metal parts

72 Two boots per package- see page 13 for more information 104 Sway bar end links included

123 Includes Sway Bar End Link Bushings

Note: For product color add R for red or G for black after each part number.

NISSAN / DATSUN (cont.)

Year	Front End Control Arm Bushing Set	Rear End Control Arm Bushing Set	Front Tension Strut Rod Bushing Set	Front Sway Bar Frame Bushings	Front or Rear End Links	Rear Sway Bar Frame Bushings	Rear Differential Carrier Bushing Set	Tie Rod Boots
------	-----------------------------------	----------------------------------	-------------------------------------	-------------------------------	-------------------------	------------------------------	---------------------------------------	---------------

300ZX

1990-96	7.3108 ⁸	7.3116	7.7105	26.5mm 7.5120		26mm 7.5119 ¹⁰⁴	7.1108 ⁵⁷	See Page 13
1990-96	Hyper-Flex® System Complete Master Set- See pg. 23						7.18105 ^{57,104}	
1990-96	Rear Sub Frame Set		7.4102		1990-96	Rear Differential Carrier Bushing Set		7.1108
1990-96	Steering Rack Bushings (w/power steering only)		7.10104					

350Z

2002-09	7.3121 ¹⁴⁰	7.3122		32mm 7.5126		21mm 7.5127	7.1119	
2002-09	Hyper-Flex® System Complete Master Set- See pg. 23						7.18108	
2002-09	Rear Sub Frame Set		7.4103		2002-09	Steering Rack Bushing		7.10105

510 (except Wagon)

1968-73	7.3107 ⁸	7.3105	7.7102				7.1104	9.13103 ⁷²
---------	---------------------	--------	--------	--	--	--	--------	-----------------------

610

1973-76	7.3103 ⁸	7.3105	7.7102					9.13103 ⁷²
---------	---------------------	--------	--------	--	--	--	--	-----------------------

810 (except Wagon)

1977-80		7.3105	7.7102					9.13103 ⁷²
---------	--	--------	--------	--	--	--	--	-----------------------

MAXIMA

2000-03	7.3118			22mm 7.5124 23mm 7.5125				
1995-99	7.3111			20mm 7.5118				
2000-03	Rear Trailing Arm Bushing Set		7.7108 ²		2000-03	Manual Transmission Shifter Stabilizer Bushing Set		7.1115
1995-03	Motor Subframe Bushing Set - Ft. Lower		7.1116 ^{57,113}		1995-03	Motor Mount Replacements (Manual Transmission Only, Two Torque Mount Positions Only)		7.1114 ^{57,113}

SENTRA, 200SX

2000-03	7.3112	7.3113						See Page 13
1995-99	7.3109	7.3120		See Page 7				
1995-99	Steering Rack Bushing Set (w/power steering only)		7.10103		1995-99	Manual Transmission Shifter Stabilizer Bushing Set		7.1109 ^{57,113}
2000-01	Motor Mount Inserts (w/2.0L engine & man. trans. only)		7.1110		2002-06	Motor Mount Inserts (w/ Spec V 2.5L engine)		7.1112

SENTRA, NX1600/2000

1991-94	7.3109	7.3110		28mm 7.5115 ¹⁰⁴		15mm 7.5116 ¹⁰⁴		
1991-94	Hyper-Flex® System Complete Master Set- w/28mm front & 15mm rear sway bar bushings- See pg. 23						7.18104	
1991-94	Manual Transmission Shifter Stabilizer Bushing Set		7.1103		1991-94	Steering Rack Bushing Set (w/power steering only)		7.10103
1991-94	Motor Mount Inserts- (2 torque mount positions only) Includes Position 1 & 2		7.1105 ¹¹³		1991-94	Motor Mount Replacement & Transmission Mount Insert Set (w/man. trans. only) Includes Position 3 & 4		7.1106 ^{57,113}

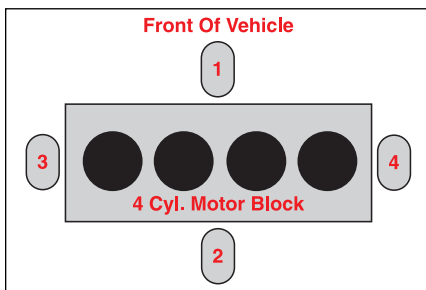

7.1106
Sentra Motor &
Transmission Mount Inserts

FOOTNOTES: 2 Must reuse existing outer metal shells 8 Lower only 57 Must reuse all metal parts
72 Two boots per package- see page 13 for more information 104 Sway bar end links included 113 With manual transmission
140 Includes tension/compression rod bushings

Note: For product color add R for red or G for black after each part number.

OLDSMOBILE

Year	Front End Control Arm Bushing Set	Rear End Control Arm Bushing Set	Rear Leaf Spring Bushing Set	Body Mount Set	Front Strut Rod Bushing Set	Front Sway Bar Frame Bushings	Front End Links	Tie Rod Boots
------	-----------------------------------	----------------------------------	------------------------------	----------------	-----------------------------	-------------------------------	-----------------	---------------

FULLSIZE- ALL (except TORONADO & FWD)

1980-92	3.3113	3.3159 ²				See page 7	9.8117	9.13101 ⁷²
1974-79	3.3105					See page 7	9.8117	9.13101 ⁷²
1971-73	3.3103					See page 7	9.8117	9.13101 ⁷²
1965-70	3.3178	3.3132				See page 7	9.8118	9.13101 ⁷²

FULLSIZE- ALL (except TORONADO & FWD)

1971-80	Transmission Mount Fits All Rear Wheel Drive- See pgs. 14 thru 17	3.1108	1977-92	Ball Joint Dust Boot Set	9.13128
Various Years	Motor Mounts- See pgs. 14 thru 20	See Charts	1974-79	Front Upper Bump Stop Set	3.9102
			1971-91	Front Lower Bump Stop Set	9.9150
			1974-92	Rear Upper Coil Spring Isolator Set	3.6108

CUTLASS, 442, F-85 & EUROPA (RWD)

1978-88	3.3156	3.3132		3.4141		See page 7	9.8119	9.13101 ⁷²
1974-77	3.3105	3.3132				See page 7	9.8118 ²¹ 9.8117 ²²	9.13101 ⁷²
1973	3.3103 ⁵ 3.3104 ⁴	3.3132				See page 7	9.8118	9.13101 ⁷²
1966-72	3.3101 ⁶ 3.3172 ⁶⁷	3.3132		3.4161 ¹⁴² for 1968-72 only		See page 7	9.8118	9.13101 ⁷²
1965	3.3117	3.3132				See page 7	9.8118	9.13101 ⁷²
1964	3.3121 ⁸	3.3133 ²⁴				See page 7	9.8118	9.13101 ⁷²

1978-87	Hyper-Flex® System Complete Master Set- See pg. 22				3.18110
1974-77	Hyper-Flex® System Complete Master Set- See pg. 22				3.18111
1966-72	Hyper-Flex® System Complete Master Set- See pg. 22				3.18112
1973-87	Ball Joint Dust Boot Set	9.13128	1974-88	Front Upper Bump Stop Set	3.9102
1964-72	Ball Joint Dust Boot Set	9.13125	1973-88	Front Lower Bump Stop Set	9.9150
1974-88	Rear Upper Coil Spring Isolator Set	3.6108	Various Years	Motor Mounts- See pgs. 14 thru 20	See Charts
			1964-87	Transmission Mount Fits All Rear Wheel Drive	3.1108

OMEGA

1975-79	3.3105		3.2103			See page 7	9.8117	9.13101 ⁷²
1973-74	3.3101		3.2103			See page 7	9.8117	9.13101 ⁷²
1975-79	Ball Joint Dust Boot Set	9.13128	1973-79	Front Lower Bump Stop Set	9.9150			
1973-74	Ball Joint Dust Boot Set	9.13125	Various Years	Motor & Transmission Mounts- Applications on pgs. 14 thru 20	See Charts			
1975-79	Front Upper Bump Stop Set	3.9102						

PONTIAC

FIERO

1984-88						23mm 9.5127	9.8117	9.13101 ⁷²
1984-88	4 Cyl. Eng. Torque Strut Bushing Set	3.7103						

FULLSIZE- BONNEVILLE (RWD), CATALINA (GRAND PRIX to '81 only) GRAND VILLE & SAFARI WAGON

1988-89	3.3113	3.3159 ²			3.1108	See page 7	See page 8	9.13101 ⁷²
1982-87	3.3156	3.3132		3.4141	3.1108	See page 7	See page 8	9.13101 ⁷²
1980-81	3.3113	3.3159 ²		3.4141	3.1108	See page 7	9.8117	9.13101 ⁷²
1974-79	3.3105				3.1108	See page 7	9.8117	9.13101 ⁷²
1971-73	3.3103				3.1108	See page 7	9.8117	9.13101 ⁷²
1977-86	Ball Joint Dust Boot Set	9.13128	1974-87	Front Upper Bump Stop Set	3.9102			
1974-87	Rear Coil Spring Isolator Set	3.6108	1971-89	Front Lower Bump Stop Set	9.9150			
			Various Years	Motor Mounts- See pgs. 14 thru 20	See Charts			

FOOTNOTES: ² Must reuse existing outer metal shells ⁴ 1³/₈" O.D. front lower ⁵ 1⁵/₈" O.D. front lower ⁶ With all round bushings ⁸ Lowers only ²¹ 1974 only ²² 1975-77 ²⁴ Uppers must reuse existing outer shells ⁶⁷ With oval rear lower bushing ⁷² Two boots per package- See page 13 for more information ¹⁴² Includes hardware

Note: For product color add R for red or G for black after each part number.



PONTIAC (cont.)

Year	Front End Control Arm Bushing Set	Rear End Control Arm Bushing Set	Rear Leaf Spring Bushing Set	Body Mount Set	Transmission Mount	Front Sway Bar Frame Bushings	Front End Links	Tie Rod Boots
------	-----------------------------------	----------------------------------	------------------------------	----------------	--------------------	-------------------------------	-----------------	---------------

FIREBIRD & TRANS AM

1993-02	3.3164 ⁵⁷	3.3136				30mm 3.5163 32mm 3.5162	9.8118	9.13101 ⁷²
1982-92	3.3157 ⁸	3.3136				30mm 3.5159 32mm 3.5130 34mm 3.5131	9.8117	9.13101 ⁷²
1980-81	3.3106		3.2103	3.4144	3.1108	See page 7	9.8117	9.13101 ⁷²
1976-79	3.3105		3.2103	3.4144	3.1108	See page 7	9.8117	9.13101 ⁷²
1974-75	3.3105		3.2103	3.4142 ¹³³	3.1108	See page 7	9.8117	9.13101 ⁷²
1973	3.3103		3.2103	3.4142 ¹³³	3.1108	See page 7	9.8117	9.13101 ⁷²
1970-72	3.3102		3.2103	3.4142	3.1108	See page 7	9.8117	9.13101 ⁷²
1967-69	3.3101		3.2101 ⁹ 3.2102 ¹⁰	3.4142	3.1108	See page 7	9.8117	9.13101 ⁷²

1993-02	Hyper-Flex® System Complete Master Set- See pg. 22							3.18130
1982-92	Hyper-Flex® System Complete Master Set- See pg. 22							3.18131
1976-79	Hyper-Flex® System Complete Master Set- See pg. 22							3.18117
1974-75	Hyper-Flex® System Complete Master Set- See pg. 22							3.18116
1967-69	Hyper-Flex® System Complete Master Set- For Vehicles With Multi Leaf Springs Only See pg. 22							3.18118
1967-69	Hyper-Flex® System Complete Master Set- For Vehicles With Mono Leaf Springs Only See pg. 22							3.18119
All	Rear Sway Bar Bushings	See page 31	1974-81	Front Upper Bump Stop Set				3.9102
1982-02	Rear Panhard Bar Bushing Set	3.7106	1970-81	Front Lower Bump Stop Set				9.9150
1982-92	Ball Joint Dust Boot Set	9.13130	1967-69	Front Lower Bump Stop Set				9.9154
1970-81	Ball Joint Dust Boot Set	9.13128	1993-97	Right Side Motor Mount Insert (8 cyl.)				3.1116
1967-69	Ball Joint Dust Boot Set	9.13125	1993-97	Left Side Motor Mount Insert (8 cyl.)				3.1127
			Various Years	Motor Mounts- See pgs. 14 thru 20				See Charts

Performance Torque Arm Mount Bushings

These performance bushings for "F" bodies reduce acceleration wheel hop, braking shudder and add greater handling control. Energy's polyurethane does not deteriorate from oils, road salt, chemicals or atmospheric conditions, such as ozone and smog. PATENT No. 6,000,672

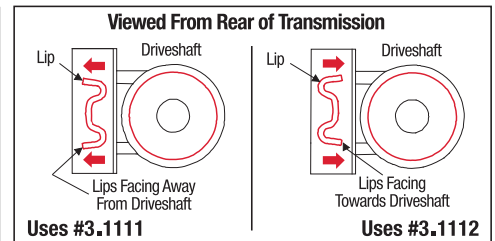

1993-04	Torque Arm Mount Bushing						3.1111 ⁵⁷
1984-92	Torque Arm Mount Bushing (Lips Facing Toward Driveshaft) SEE DIAGRAM ABOVE						3.1112 ⁵⁷
1984-92	Torque Arm Mount Bushing (Lips Facing Away From Driveshaft) SEE DIAGRAM ABOVE						3.1111 ⁵⁷
1982-83	Torque Arm Mount Bushing						3.1110 ⁵⁷

Leaf Spring Isolators

Year	Model	Leaf Spring Pad Set #
		Set Includes: 2 Upper Pads 2 Lower Pads
1970-81	Firebird (multi-leaf)	3.6111
1968-69	Firebird (multi-leaf)	3.6112
1967-69	Firebird (mono-leaf)	3.6113



Polyurethane Leaf Spring Isolators

FOOTNOTES: 8 Lower only 9 Mono leaf spring 10 Multi leaf spring 57 Must reuse all metal parts
72 2 boots per package- See page 13 for more information 133 1973-75 with 1" hole in core support order 3.4157

Note: For product color add R for red or G for black after each part number.

Continued
Next Page



PONTIAC (cont.)

Year	Front End Control Arm Bushing Set	Rear End Control Arm Bushing Set	Rear Leaf Spring Bushing Set	Body Mount Set	Transmission Mount	Front Sway Bar Frame Bushings	Front End Links	Tie Rod Boots
------	-----------------------------------	----------------------------------	------------------------------	----------------	--------------------	-------------------------------	-----------------	---------------

GTO

2004-06	3.3187 ¹⁵³	3.3188				28mm 3.5210	9.8161	
2004-06	Hyper-Flex® System Complete Master Set - See pg. 23							3.18134 ¹⁵³
2004-06	Rear Sway Bar Bushing Set 16mm		3.5211	2004-06	Rear Sub Frame Bushing Set		3.4125 ¹²⁶ 3.4164 ¹²⁷	

LEMANS, GTO, TEMPEST, GRAND AM (to '81), GRAND PRIX (1982 thru '88)

1982-88	3.3156 ⁷¹	3.3132 ⁷¹		3.4141	3.1108		9.8117 ⁷¹	9.13101 ⁷²
1978-81	3.3156	3.3132			3.1108	See page 7	9.8119	9.13101 ⁷²
1974-77	3.3105	3.3132			3.1108	See page 7	9.8117	9.13101 ⁷²
1973	3.3103 ⁵ 3.3104 ⁴	3.3132			3.1108	See page 7	9.8117	9.13101 ⁷²
1967-72	3.3172 ⁶⁷	3.3132			3.1108	See page 7	9.8118	9.13101 ⁷²
1965-66	3.3117	3.3132			3.1108	See page 7	9.8118	9.13101 ⁷²
1964	3.3117	3.3133 ²⁴			3.1108	See page 7	9.8118	9.13101 ⁷²

1982-88	Grand Prix Hyper-Flex® System Complete Master Set- See pg. 22							3.18110
1978-81	Grand Am Hyper-Flex® System Complete Master Set- See pg. 22							3.18110
1974-77	All Models Shown Above Hyper-Flex® System Complete Master Set- See pg. 22							3.18111
1967-72	All Models Shown Above Hyper-Flex® System Complete Master Set- See pg. 22							3.18112
1974-81	Front Upper Bump Stop Set		3.9102	1974-88	Rear Upper Coil Spring Isolator Set		3.6108	
1971-81	Front Lower Bump Stop Set		9.9150	Various Years	Motor Mounts- See pgs. 14 thru 20		See Charts	
				1964-81	Ball Joint Dust Boot Set		9.13128	

PHOENIX & VENTURA

1978-79	3.3105		3.2103		3.1108	See page 7	9.8117	9.13101 ⁷²
1975-77	3.3105		3.2103		3.1108	See page 7	9.8117	9.13101 ⁷²
1971-74	3.3101		3.2103		3.1108	See page 7	9.8118	9.13101 ⁷²
1975-79	Front Upper Bump Stop Set		3.9102	1975-79	Ball Joint Dust Boot Set		9.13128	
1973-79	Front Lower Bump Stop Set		9.9150	1971-74	Ball Joint Dust Boot Set		9.13125	

SCION

Year	Front End Control Arm Bushing Set	Rear End Control Arm Bushing Set	Rear Leaf Spring Bushing Set	Body Mount Set	Transmission Mount	Front Sway Bar Frame Bushings	Rear Sway Bar Bushing Set	Tie Rod Boots
------	-----------------------------------	----------------------------------	------------------------------	----------------	--------------------	-------------------------------	---------------------------	---------------

FR-S

 2013-15	8.3130	8.3131				18mm 8.5138	14mm 8.5139 ¹⁰⁴	
2013-15	Rack & Pinion Bushing Set		8.10105	2013-15	Transmission Shifter Bushing Set		8.1105 ¹¹³	
2013-15	Hyper-Flex® System Complete Master Set- See pg. 24							8.18115

Year	Front Control Arm Bushing Set	Rear Trailing Arm Bushing Set	Front Sway Bar Frame Bushings	Rear Sway Bar Frame Bushings	Rear Sub Frame Bushing Set
------	-------------------------------	-------------------------------	-------------------------------	------------------------------	----------------------------

TC

2005-07	8.3120	8.3125 ⁸	21mm 8.5131	18mm 8.5132	8.4108
2005-07	Hyper-Flex® System Complete Master Set- See pg. 24				8.18110
2005-07	Motor Mount Inserts (3 Torque Mount Positions Only)		8.1104		

XB

2004-07	8.3123	8.3124	25mm 8.5130 ¹⁰⁴		
2004-07	Motor Mount Inserts (3 Torque Mount Positions Only)		8.1103		

FOOTNOTES: 4 1 3/8" O.D. front lower 5 1 5/8" O.D. front lower 8 Lower only 24 Uppers must reuse existing outer shells 67 With oval rear lower bushing 71 Grand Prix only 72 2 boots per package- See page 13 for more information 104 Sway bar end links included 113 With manual transmission 126 Street Performance 127 Race Performance Only 153 Does not include strut rod bushings

Note: For product color add R for red or G for black after each part number.



SUBARU

Year	Front End Control Arm Bushing Set	Rear Control Arm Bushing Set	Front Strut Rod Bushing Set	Rack & Pinion Bushing Set	Front Sway Bar Frame Bushings	Front End Links	Rear Sway Bar Frame Bushings	Tie Rod Boots
------	-----------------------------------	------------------------------	-----------------------------	---------------------------	-------------------------------	-----------------	------------------------------	---------------

BRZ

NEW 2013-15	8.3130	8.3131		8.10105	18mm 8.5138		14mm 8.5139 104	
--------------------	--------	--------	--	---------	-------------	--	-----------------	--

2013-15	Transmission Shifter Bushing Set			8.1105 113
---------	----------------------------------	--	--	------------

NEW 2013-15	Hyper-Flex® System Complete Master Set						8.18115
--------------------	--	--	--	--	--	--	---------

FORESTER

2009-13	19.3102				21mm 19.5105			
---------	---------	--	--	--	--------------	--	--	--

2009-13	Transmission X-Member Bushing Set		19.1103 113	2000-08	Transmission Shifter Bushing Set		19.1102 113
---------	-----------------------------------	--	-------------	---------	----------------------------------	--	-------------

IMPREZA, WRX, STi

NEW 2008-14	19.3102	19.3103		19.10101	21mm 19.5105		16mm 19.5106	
2002-06	19.3101	19.7101			20mm 19.5101		17 mm 19.5104 20 mm 19.5102	

2002-06	Rear Trailing Arm Bushing Set		19.7101
---------	-------------------------------	--	---------

2002-06	Hyper-Flex® System Complete Master Set- See pg. 24						19.18101
---------	--	--	--	--	--	--	----------

2002-14	Transmission Shifter Bushing Set		19.1102 113	2008-14	Transmission X-Member Bushing Set		19.1103 113
---------	----------------------------------	--	-------------	---------	-----------------------------------	--	-------------

LEGACY

NEW 2005-09	19.3104	19.3105			21mm 19.5105		16mm 19.5107	
--------------------	---------	---------	--	--	--------------	--	--------------	--

2005-09	Transmission X-Member Bushing Set		19.1103 113	2000-09	Transmission Shifter Bushing Set		19.1102 113
---------	-----------------------------------	--	-------------	---------	----------------------------------	--	-------------

TOYOTA

Year	Front End Control Arm Bushing Set	Rear End Control Arm Bushing Set	Front Strut Rod Bushing Set	Rear Trailing Arm Bushing Set	Front Sway Bar Frame Bushings	Front End Links	Rear Sway Bar Frame Bushings	Tie Rod Boots
------	-----------------------------------	----------------------------------	-----------------------------	-------------------------------	-------------------------------	-----------------	------------------------------	---------------

AVALON

1995-03	8.3117			8.3118	19mm 9.5123 18mm 9.5122		16mm 8.5120	
---------	--------	--	--	--------	----------------------------	--	-------------	--

CAMRY

1997-01	8.3117			8.3118	19mm 9.5123 18mm 9.5122		16mm 8.5120	
---------	--------	--	--	--------	----------------------------	--	-------------	--

CELICA, GTS

2000-05	8.3119 57				22mm 8.5124 29		17.5mm 8.5125 29	
1978-85	8.3101 2	8.3109 90	8.7102		See page 7	9.8122		9.13101 72

2000-05	Hyper-Flex® System Complete Master Set- See pg. 24						8.18106
---------	--	--	--	--	--	--	---------

COROLLA-FWD

2003-04	8.3120	8.3121		8.10102	24mm 8.5128 29			
1970-86	8.3101 2		8.7102		See page 7	9.8122		9.13101 72

2000-05	Rack & Pinion Bushing Set		8.10102 57
---------	---------------------------	--	------------

COROLLA-RWD SR-5 / GTS

1985-87	8.3101 2		8.7102		See page 7	9.8122		9.13101 72
---------	----------	--	--------	--	------------	--------	--	------------

CRESSIDA

1978-88	8.3101 2				See page 7	See page 8		9.13101 72
---------	----------	--	--	--	------------	------------	--	------------

MATRIX

2003-06	8.3120	8.3121			24mm 8.5128 29			
---------	--------	--------	--	--	----------------	--	--	--

2003-06	Motor Mount Inserts (2 Torque Mount Positions Only)		8.1101
---------	--	--	--------

MR2

1992-95	8.3110 66	8.3111 66			19mm 8.5110		19mm 8.5111	
---------	-----------	-----------	--	--	-------------	--	-------------	--

SOLARA

1999-03	8.3117			8.3118	18mm 9.5122 19mm 9.5123		16mm 8.5120	
---------	--------	--	--	--------	----------------------------	--	-------------	--

SUPRA

1993-98					30mm 8.5121		22mm 8.5122 29	
1987-92	8.3126	8.3127			27mm 8.5133		23mm 8.5134	
1982-85	8.3101 2	8.3112	8.7102		See page 7	9.8122		9.13101 72
1979-81	8.3101 2	8.3109	8.7102		See page 7	9.8122		9.13101 72

FOOTNOTES: 2 Must reuse existing outer metal shells 29 Greaseable frame bushings 57 Must reuse all metal parts 66 Includes strut bushings 72 Two boots per package- See page 13 for more information 90 GTS use 8.3112 104 Sway bar end links included 113 With manual transmission

Note: For product color add R for red or G for black after each part number.



VOLKSWAGEN - WATER COOLED

Performance Control Arm Bushing Set Including Hardware.



When it comes to performance, modifying Volkswagens has always been a favorite task among enthusiasts. But they're not really done without focusing on critical suspension bushings, especially when upgrading tires.



Year	Front End Control Arm Bushing Set	Rear End Axle Beam Bushing Set	Front Sway Bar Bushing Set	Rear Sway Bar Bushing Set	Rear Coil Spring Isolators	Rear Strut Tower Bushing Set
------	-----------------------------------	--------------------------------	----------------------------	---------------------------	----------------------------	------------------------------

BEETLE (new version)

1998-06	15.3117	15.3118	21mm 15.5105 ¹⁰⁴		15.6104	
1998-06	Motor Mount (manual transmission only, lower torque position only)			15.1105 ¹⁰⁸		

CABRIO

1993-99	15.3113	15.3119	17mm 15.5101 ¹⁰⁴ 19mm 15.5102 ¹⁰⁴		15.6103	
---------	---------	---------	--	--	---------	--

CORRADO (4 cyl only)

1990-95	15.3113	15.3114	17mm 15.5101 ¹⁰⁴ 19mm 15.5102 ¹⁰⁴		15.6103	15.8101
1990-95	Hyper-Flex® System Master Set- See pg. 24					15.18101

GOLF R

 2012-14	15.3120		22mm 15.5107	20mm 15.5110 19mm 15.5109 18mm 15.5108	15.6105	
2012-14	Rear End Control Arm Bushing Set		15.3121 ²³			

GOLF IV, GTI and JETTA IV

1999-06	15.3117	15.3118	23mm 15.5106 ¹⁰⁴		15.6104	
1999-06	Motor Mount (manual transmission only, lower torque position only)			15.1105 ¹⁰⁸		

GOLF III & GTI

1993-99	15.3113	15.3119	17mm 15.5101 ¹⁰⁴ 19mm 15.5102 ¹⁰⁴		15.6103	15.8101
---------	---------	---------	--	--	---------	---------

GOLF II & GTI

1985-92	15.3113	15.3114			15.6103	15.8101
1985-92	Hyper-Flex® System Master Set- See pg. 24					15.18101

JETTA III

1993-99	15.3113	15.3119			15.6103	15.8101
---------	---------	---------	--	--	---------	---------

JETTA II

1985-92	15.3113	15.3114	17mm 15.5101 ¹⁰⁴ 19mm 15.5102 ¹⁰⁴		15.6103	15.8101
1985-92	Hyper-Flex® System Master Set- See pg. 24					15.18101

PASSAT

1990-97	15.3113					
---------	---------	--	--	--	--	--

RABBIT

1980-92	15.3115	15.3116	17mm 15.5103 ¹⁰⁴	21mm 15.5104		
---------	---------	---------	-----------------------------	--------------	--	--

SCIROCCO

1982-88		15.3116	17mm 15.5103 ¹⁰⁴			
---------	--	---------	-----------------------------	--	--	--

Motor Mount "Torque Arm" Inserts

Eliminates excess engine movement, resulting in wheel hop from the stock rubber mounts. Benefit from additional strength and toughness, thanks to Hyper-Flex® polyurethane support for the existing rubber mounts. Fits all motor & transmission combinations for the following:

Year	Model	Set#
2008.5-12	EOS 2.0, 3.2	15.1107
2009-12	CC	
2008.5-09	GTI MKV	
2010-12	GTI MKVI	
2008.5-12	Jetta VI 2.0	
2008.5-12	Passat	
2009-12	Tiguan	15.1106
2007-08	EOS	
2006-08	GTI MKV	
2005-08	Jetta V 2.0, 2.5	
2006-08	Passat	
2007-09	Rabbit MKV	

Please note 2008 split year



FOOTNOTES: ²³ Front lowers must reuse existing outer shells ¹⁰⁴ Sway bar end links included ¹⁰⁸ Not including diesel engine

Note: For product color add R for red or G for black after each part number.

VOLKSWAGEN - AIR COOLED



Front Control Arm Bushing Set w/Sway Bar Bushings

Year	Description	Set Number
------	-------------	------------

FRONT CONTROL ARM BUSHING SET (INCLUDES SWAY BAR BUSHINGS)

1971-7/73	Super Beetle (Cast)	15.3106
8/1973-79	Super Beetle (Stamped)	15.3107

REAR CONTROL ARM BUSHING SET

1968-78	Type I with IRS	15.3105
---------	-----------------	---------



Rear Spring Plate Bushing Set

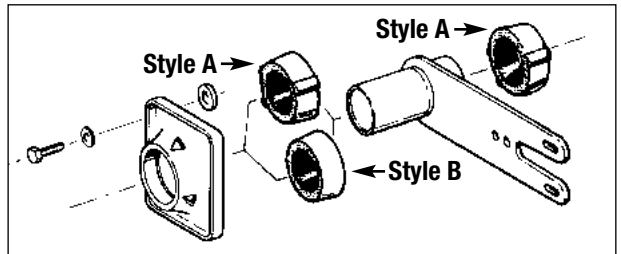

Due to the many variations of suspensions on Baja bugs, sand rails, etc., these Rear Spring Plate Bushings are sold two ways.



Motor & Transmission Mount Set 15.1101

MOTOR AND TRANSMISSION MOUNTS (INCLUDES HARDWARE)

1961-73	VW Type I	15.1101
---------	-----------	---------

FRONT AND REAR BUMP STOP (TYPE I)

1956-65	Front Bump Stop	15.6101
1958-79	Rear Bump Stop	15.6102

FRONT TORSION ARM BUSHING (TYPE I)

1958-65	King Pin Suspension – One Piece Design Services Inner and Outer	15.3101
1966-78	Ball Joint Suspension – One Piece Design Services Inner and Outer	15.3103

NOTE: Replaces original needle bearing type design.

SHIFTER COUPLER BUSHINGS

1964-79	VW TYPE I	15.1103
---------	-----------	---------

Year	Description	Set Number
------	-------------	------------

1) SERVICES STOCK SUSPENSION, 4 Bushings Per Set (TYPE I)

1953-68	Swing Axle Suspension Two 1 ³ / ₄ " I.D. Knobby Style (A)	15.2108
	Two 1 ⁷ / ₈ " I.D. Knobby Style (A)	
1969-78	Independent Rear Suspension Two 1 ⁷ / ₈ " I.D. Round Style (B)	15.2109
	Two 1 ⁷ / ₈ " I.D. Knobby Style (A)	

2) SERVICES AFTERMARKET SUSPENSION, Packaged 2 Bushings Per Set (TYPE I)

1 ³ / ₄ " I.D. Knobby Style (A)	15.2110
1 ⁷ / ₈ " I.D. Knobby Style (A)	15.2111
1 ⁷ / ₈ " I.D. Round Style (B)	15.2114



Front Torsion Arm Bushing Set

Note: For product color add R for red or G for black after each part number.

GENERAL MOTORS 2WD

Trucks subject suspension bushings to all the same conditions as passenger vehicles and then some! With increased component loads and torturous on- and off-road conditions, too soft O.E.M. rubber bushings unfortunately allow the suspension to deflect. Energy Suspension's Hyper-Flex® performance polyurethane bushings prevents this unnecessary deflection. They are full floating allowing proper weight transfer and full suspension travel.



Year	Front End Control Arm Bushing Set	Rear End Control Arm Bushing Set	Front Leaf Spring Bushing Set	Rear Leaf Spring Bushing Set	Body (Cab) Mount Set	Complete Front Sway Bar Bushing Set	Tie Rod Boots
------	-----------------------------------	----------------------------------	-------------------------------	------------------------------	----------------------	-------------------------------------	---------------

S-10 & S-15 PICKUP 2WD (except '97-01 SS)

1982-04	3.3162			3.2129 3.2142 122	3.4130 89 3.4131 36	1" 3.5126 29,104 1 1/16" 3.5122 29,104 1 1/8" 3.5190 29,104	9.13101 72
1982-04	S-10, S-15 PU Hyper-Flex® System Complete Master Set- See pg. 25						3.18106
1982-04	Front Upper & Lower Coil Spring Isolators		9.6102	1982-04	Front Upper Bump Stop Set		3.9102

S-10 BLAZER, S-15 JIMMY 2WD

1982-04	3.3162			3.2129 3.2142 122	3.4132	1" 3.5126 104 1 1/16" 3.5122 104 1 1/8" 3.5190 104	9.13101 72
1982-04	Front Upper & Lower Coil Spring Isolators		9.6102	1982-04	Front Upper Bump Stop Set		3.9102

ESCALADE & ESCALADE EXT

2007	3.3190 57,128	3.3194			3.4156		
2002-06	3.3190 57,128,138	3.3194 138			3.4156	32mm 3.5214 29,104	
2002-06	Rear Sway Bar Bushing Set 28mm		3.5215 123				

TAHOE, YUKON & DENALI (EXCEPT XL) 2WD

2007	3.3190 57 128	3.3194			3.4156		
2000-06	3.3190 57 128	3.3194			3.4156	32mm 3.5214 29,104	
1995-99	3.3147 2 57			3.2128	3.4146	1 1/4" 3.5178 29 104	9.13101 72
1995-99	Tahoe & Yukon Hyper-Flex® System Complete Master Set- See pg. 25						3.18124
2000-06	Rear Sway Bar Bushing Set 28mm		3.5215 123	1995-99	Rear Sway Bar Bushing Set 22mm		3.5205

K-5 BLAZER (thru '94), DENALI XL, SUBURBAN & YUKON XL 2WD

2007	3.3190 57,128	3.3194					
2000-06	3.3190 57,128,138	3.3194 138				32mm 3.5214 29,104	
1992-99	3.3147 2,57			3.2128 3.2126 129	3.4148 77	1 1/4" 3.5178 29,104	9.13101 72
1981-91	3.3161 (1/2 ton only)			See Chart Page 57	3.4124 77	1 1/16" 3.5175 29,123 1 1/8" 3.5176 29,123 1 1/4" 3.5177 29,123	9.13119 72
1973-80	3.3161 (1/2 ton only)			See Chart Page 57	3.4147 77	1 1/16" 3.5175 29,123 1 1/8" 3.5176 29,123 1 1/4" 3.5177 29,123	9.13119 72
1967-72					3.4149 77		
1992-99	Suburban Hyper-Flex® System Complete Master Set- See pg. 25						3.18126
2000-06	Rear Sway Bar Bushing Set 28mm		3.5215 123 138	1973-87	Front Upper Bump Stop Set		3.9102
1992-99	Rear Sway Bar Bushing Set 22mm		3.5205				
1992-97	Ball Joint Dust Boot Set		9.13126				

ASTRO VAN 2WD

1990-04	3.3173					See Page 7	9.13101 72
1985-89	3.3113					1 1/4" 3.5178 29,104	9.13101 72
1987-89	Ball Joint Dust Boot Set		9.13128	1985-98	Front Upper & Lower Coil Spring Isolators		9.6102

1/2 TON G10, 3/4 TON G20 VANS

1996-02	3.3147 2,57						
1973-95	3.3161					1 1/16" 3.5175 29,123	9.13119 72
1973-96	Front Upper Bump Stop Set		3.9102				

FOOTNOTES: 2 Must reuse existing outer metal shells 29 Greaseable Frame Bushings 36 Extended cab only 57 Must reuse all metal parts 72 2 boots per package- See page 12 for more information 77 Suburban only 89 Standard cab only 104 Sway bar end links included 122 2 1/2" main eye O.D. 123 Includes sway bar end link bushings 128 With torsion bar front suspension 129 With 1 7/8" OD shackle bushings 138 1500 Only

Note: For product color add R for red or G for black after each part number.

GENERAL MOTORS 2WD (cont.)

Year	Front End Control Arm Bushing Set	Rear End Control Arm Bushing Set	Front Leaf Spring Bushing Set	Rear Leaf Spring Bushing Set	Body (Cab) Mount Set	Complete Front Sway Bar Bushing Set	Tie Rod Boots
------	-----------------------------------	----------------------------------	-------------------------------	------------------------------	----------------------	-------------------------------------	---------------

AVALANCHE 2WD

2007	3.3190 ^{57,128}	3.3194					
2002-06	3.3190 ^{57,128,138}	3.3194 ¹³⁸				32mm 3.5214 ^{29,104}	
2002-06	Rear Sway Bar Bushing Set 28mm		3.5215 ^{123,138}				

C1500 Silverado 2WD

1999-06	3.3186 ^{2,57}			3.2141	3.4150	32mm 3.5214 ^{29,104}	
1999-06	Silverado <i>Hyper-Flex</i> ® System Complete Master Set- See pg. 25						3.18129

1/2 TON C-10/C1500 PICKUP 2WD

1988-98	3.3147 ^{2,57}			3.2128 ¹⁰⁶ 3.2126 ¹²⁹	3.4122 ⁷⁶ 3.4123 ⁸⁹	1 1/4" 3.5178 ^{29,104}	9.13101 ⁷²
1981-87	3.3161			See Chart Below	3.4116	1 1/16" 3.5175 ^{29,123} 1 1/8" 3.5176 ^{29,123} 1 1/4" 3.5177 ^{29,123}	9.13119 ⁷²
1973-80	3.3161			See Chart Below	3.4109	1 1/16" 3.5175 ^{29,123} 1 1/8" 3.5176 ^{29,123} 1 1/4" 3.5177 ^{29,123}	9.13119 ⁷²
1967-72		3.3123 ⁵⁷			3.4108	1 1/16" 3.5175 ^{29,123}	9.13119 ⁷²
1963-66		3.3123 ⁵⁷			3.4137		9.13119 ⁷²

1988-98	Hyper-Flex® System Complete Master Set- See pg. 25						3.18107
1981-87	Hyper-Flex® System Complete Master Set- See pg. 25						3.18108
1973-80	Hyper-Flex® System Complete Master Set- See pg. 25						3.18109
1988-98	Rear Spring- Frame Shackle Bushings Only		3.2139	1973-98	Front Upper Bump Stop Set		3.9102
1988-98	Front Shock Bushing Set- O. E. Shocks Only		9.8137 ⁵⁷	1960-72	Rear Tracking Arm Bushing Set (Panhard Bar)		3.7104 ²
1988-98	Rear Shock Bushing Set- O. E. Shocks Only		9.8138 ⁵⁷	1988-98	Coil Lift Isolator Set (front only-1.25" lift)		3.6115
1988-98	Ball Joint Dust Boot Set		9.13126	1963-72	Motor Mount		3.1156

C2500 HD Silverado 2WD

2001-06	3.3185 ^{2,57}			3.2141	3.4150	36mm 3.5213 ^{29,104}	
2001-06	Silverado <i>Hyper-Flex</i> ® System Complete Master Set- See pg. 25						3.18128

3/4 TON C-20/C2500, 1 TON C-30/C3500 2WD

1988-01	3.3147 ^{2,57,106}			3.2128 ¹⁰⁶ 3.2126 ¹²⁹	3.4121 ^{42,106} 3.4122 ^{76,106} 3.4123 ^{89,106}	1 1/4" 3.5178 ^{29,104}	9.13101 ⁷²
1981-87				See Chart Below	3.4116 3.4121 ⁷⁵	1 1/4" 3.5177 ^{29,123}	9.13119 ⁷²
1973-80				See Chart Below	3.4103 ⁸⁹ 3.4140 ^{20,75}	1 1/4" 3.5177 ^{29,123}	9.13119 ⁷²
1967-72		3.3123 ²			3.4107	1 1/16" 3.5175 ^{29,123}	9.13119 ⁷²

1988-01	Hyper-Flex® System Complete Master Set- See pg. 25						3.18107 ¹⁰⁶
1988-01	Ball Joint Dust Boot Set- See pg. 12		9.13126 ¹⁰⁶	1981-87	Dually Rear Complete Sway Bar Bushing Set For 1 1/16" Bar		3.5120
1967-72	Rear Tracking Arm Bushing Set (Panhard Bar)		3.7116				

Leaf Spring Bushings- for 2WD Rear O.E.M. Springs (COMPLETE SET INCLUDES SHACKLE BUSHINGS) 12 BUSHINGS, 6 SLEEVES

Model	Description	Year	Complete Rear Leaf Spring Bushing Set	Frame Shackle Eye Set
Blazer to '91, C-10, C-20, C-30 2WD with 1550 to 2000 lb. Axle Rating	With 1 1/2" O.D. Frame Shackle (1 1/2" Main Eye)	1973-87	3.2106	1 3/8" use 3.2126
	With 1 3/8" O.D. Frame Shackle (1 1/2" Main Eye)	1981-87	3.2108	1 1/2" use 3.2124
	With 1 1/2" O.D. Frame Shackle (1 3/4" Main Eye)	1973-87	3.2107	1 3/4" use 3.2125
C-20, C-30 2WD with 2600 to 3500 lb. Axle Rating	With 1 3/8" O.D. Frame Shackle (1 3/4" Main Eye)	1981-87	3.2113	4 Bushings, 2 Sleeves Services 2 Shackles
	With 1 3/4" O.D. Frame Shackle	1973-87	3.2120	

FOOTNOTES: 2 Must reuse existing outer metal shells 20 1975-79 29 Greaseable Frame Bushings 42 1988-91 Crew cab only 57 Must reuse all metal parts 72 2 Boots per package- See page 13 for more information 75 Crew cab only 76 Extra cab only 89 Standard cab only 104 Sway bar end links included 106 Does not include '99-01 new body Silverado 123 Includes Sway Bar End Link Bushings 128 With torsion bar front suspension 129 With 1 7/8" O.D. shackles (shackle bushings only) 138 1500 Only

Note: For product color add R for red or G for black after each part number.



GENERAL MOTORS 4WD

General Motors 4WD trucks and SUVs are set up from the factory with too soft, mushy bushings. Fine perhaps for freeway driving, but take these vehicles off the highway or do some real performance driving and it's a different story!

Energy's Hyper-Flex® performance polyurethane components cure handling and control problems, providing for the wants and needs of the enthusiast and anyone who wants a stable running rig.



TRUCKS

Year	Front End Control Arm Bushing Set	Rear End Control Arm Bushing Set	Front Leaf Spring Bushing Set	Rear Leaf Spring Bushing Set	Body (Cab) Mount Set	Complete Front Sway Bar Bushing Set	Tie Rod Boots
------	-----------------------------------	----------------------------------	-------------------------------	------------------------------	----------------------	-------------------------------------	---------------

S-10, S-15 PICKUP 4WD

1994-04	3.3119 24,58			3.2129 3.2142 122	3.4130 3.4131 36	28mm 3.5206 104 33mm 3.5207 104	9.13101 72
1983-93	3.3119 24,58			3.2129 3.2142 122	3.4130 3.4131 36	25mm 3.5156 ^{29,123} 28mm 3.5121 ^{29,123} 32mm 3.5158 ^{29,123}	9.13101 72

1983-87	Front Differential Carrier Bracket Bushing Set		3.1105	1982-93	Transmission Mount		3.1129
				1982-01	Motor Mounts- See pgs. 16 thru 20		See Charts

S-10 BLAZER, S-15 JIMMY 4WD

1995-04	3.3119 24,58			3.2129	3.4132	28mm 3.5206 104 33mm 3.5207 104	9.13101 72
1983-94	3.3119 24,58			3.2129	3.4132	25mm 3.5156 ^{29,123} 28mm 3.5121 ^{29,123} 32mm 3.5158 ^{29,123}	9.13101 72

1983-87	Front Differential Carrier Bracket Bushing Set		3.1105	1982-94	Transmission Mount (V6-automatic transmission)		3.1129
				1982-01	Motor Mounts- See pgs. 16 thru 20		See Charts

SYCLONE, TYPHOON 4WD

1991-93	3.3119 24,58			3.2129	3.4132	32mm 3.5186 123	9.13101 72
---------	--------------	--	--	--------	--------	-----------------	------------

1991-93	Transmission Mount (V6-automatic transmission)		3.1129
---------	--	--	--------

Motor Mounts Available for 2.8L & 4.3L V6.

The Perfect Match For Your Power Upgrading, Engine Swapping-Or Adding Greater Durability!

The 3.1141 & 3.1144 Mounts Incorporate Our Proven Metal Interlock.

3.1145 2.8L Motor Mount Insert
See pages 19-20



3.1141 4.3L Motor Mount

Year	Front End Control Arm Bushing Set	Rear End Control Arm Bushing Set	Rear Leaf Spring Bushing Set	Body (Cab) Mount Set	Complete Front Sway Bar Bushing Set	Complete Rear Sway Bar Bushing Set	Tie Rod Boots
------	-----------------------------------	----------------------------------	------------------------------	----------------------	-------------------------------------	------------------------------------	---------------

ESCALADE & ESCALADE EXT 4WD

2007	3.3190 57,128	3.3194		3.4156			
2002-06	3.3190 57,128,138	3.3194 138		3.4156	32mm 3.5214 29,104	22mm 3.5215 29,123	

HUMMER H1

1994-06	3.3189	3.3189			1" 3.5212 123		
---------	--------	--------	--	--	---------------	--	--

1994-06	Ball Joint Dust Boot Set		9.13136
---------	--------------------------	--	---------

HUMMER H2

2003-07		3.3194					
---------	--	--------	--	--	--	--	--

TAHOE, YUKON & DENALI (EXCEPT XL) 4WD

2007	3.3190 57,128	3.3194		3.4156			
2000-06	3.3190 57,128	3.3194		3.4156	32mm 3.5214 29,104	28mm 3.5215 29,123	
1998-99	3.3180 58		3.2128 3.2126 129	3.4146		3.5205 29,123	9.13101 72
1995-97	3.3134 57		3.2128 3.2126 129	3.4146	30mm 3.5181 29,104 32mm 3.5204 29,104	3.5205 29,123	

1995-97	Yukon & Tahoe Hyper-Flex® System Complete Master Set- See pg. 25						3.18125
---------	--	--	--	--	--	--	---------

FOOTNOTES: 24 Uppers must reuse existing outer shells 29 Greaseable Frame Bushings 36 Extended cab only 57 Must reuse all metal parts
58 Uppers must reuse all hardware 72 2 boots per package- See page 13 for more information 104 Sway bar end links included
122 2 1/2" main eye O.D. 123 Includes sway bar end link bushings 128 With torsion bar front suspension
129 With 1 7/8" OD shackle bushings 138 1500 only

Note: For product color add R for red or G for black after each part number.

Continued
Next Page

ENERGYSUSPENSION.COM



GENERAL MOTORS 4WD (cont.)



DIESEL MOTOR MOUNT INSERTS!

High horsepower-high torque GM diesel engines demand our performance polyurethane mount inserts. Gain dramatic increase in durability and a torque resistance you can't find anywhere else!

See pages 19-20



Hyper-Flex® System Complete Master Set contains most part numbers shown below.

Year	Front End Control Arm Bushing Set	Rear End Control Arm Bushing Set	Front Leaf Spring Bushing Set	Rear Leaf Spring Bushing Set	Body (Cab) Mount Set	Complete Front Sway Bar Bushing Set	Tie Rod Boots
------	-----------------------------------	----------------------------------	-------------------------------	------------------------------	----------------------	-------------------------------------	---------------

K5 BLAZER (THRU '95), DENALI XL, SUBURBAN & YUKON XL 4WD

2007	3.3190 57,128	3.3194					
2000-06	3.3190 57,128,138	3.3194 138				28mm 3.5222 123,138 32mm 3.5214 123,138	
1998-99	3.3180 58			3.2128 3.2126 129	3.4148 77	30mm 3.5181 29,104 32mm 3.5204 29,104	
1992-97	3.3134 57			3.2128 3.2126 129	3.4118 37 3.4148 77	30mm 3.5181 29,104 32mm 3.5204 29,104	9.13101 72
1988-91			3.2130 3.2132 40	3.2128 3.2126 129	3.4118 37 3.4124 77	1 1/4" OD 3.5118 123	9.13119 72
1981-87			3.2105 3.2112 40	See Chart Page 60	3.4118 37 3.4124 77	1 1/4" OD 3.5118 123	9.13119 72
1978-80			3.2105 3.2112 40	See Chart Page 60	3.4104 37 3.4147 77	1 1/16" OD 3.5179 29,123 1 1/4" OD 3.5180 29,123	9.13119 72
1973-77			3.2105 3.2112 40	See Chart Page 60	3.4105 37 3.4147 77	1 1/16" OD 3.5179 29,123 1 1/4" OD 3.5180 29,123	9.13119 72
1971-72			3.2105	3.2106	3.4149 3.4110 37		9.13119 72
1967-70			3.2131	3.2106	3.4149 3.4110 37		9.13119 72

1992-97	Suburban Hyper-Flex® System Complete Master Set- See pg. 25					3.18127
1992-02	Transmission Mount (automatic transmission)	3.1129	1971-91	Front Frame Shackle Eye Set 4 Bushings 2 Sleeves	3.2111	
2000-06	Rear Sway Bar Bushing Set 28mm	3.5215 123,138	1985-99	Transmission Mount (V6-automatic transmission)	3.1129	
1992-99	Rear Sway Bar Bushing Set 22mm	3.5205 29,123	1968-84	Transmission Mounts (2 per set) For K5 (Blazer), K10, K20, K30, Suburban	3.1106	
Various Years	Motor Mounts- See pgs. 14 thru 20	See Charts	1960-75	Transfer Case Torque Mount For K5 (Blazer), K10, K20, K30, Suburban	3.1107	

AVALANCHE 1500 4WD

2007	3.3190 57,128	3.3194					
2002-06	3.3190 57,128	3.3194				28mm 3.5222 29,123 32mm 3.5214 29,123	
2002-06	Rear Sway Bar Bushing Set 28mm		3.5215 123				

AVALANCHE 2500 4WD

2001-06	3.3185 58			3.2141	3.4150	36mm 3.5213 29,104	
---------	-----------	--	--	--------	--------	--------------------	--

K1500 SILVERADO 4WD

1999-06	3.3190 57,128			3.2141	3.4150	28mm 3.5222 29,123 32mm 3.5214 29,123	
---------	---------------	--	--	--------	--------	--	--

FOOTNOTES: 29 Greaseable Frame Bushings 37 Blazer only 40 Aftermarket springs except Superlift and Skyjacker 57 Must reuse all metal parts 58 Uppers must reuse all hardware 72 2 boots per package- See page 13 for more information 77 Suburban only 104 Sway bar end links included 123 Includes sway bar end link bushings 128 With torsion bar front suspension 129 With 1 7/8" OD shackle bushings 138 1500 only

Note: For product color add R for red or G for black after each part number.

Continued
Next Page



GENERAL MOTORS 4WD (cont.)

TRUCKS

Year	Front End Control Arm Bushing Set	Rear End Control Arm Bushing Set	Front Leaf Spring Bushing Set	Rear Leaf Spring Bushing Set	Body (Cab) Mount Set	Complete Front Sway Bar Bushing Set	Tie Rod Boots
------	-----------------------------------	----------------------------------	-------------------------------	------------------------------	----------------------	-------------------------------------	---------------

K2500 / 3500HD

NEW 2007-10	3.3185 ⁵⁸			3.2141	3.4162 ⁵⁷	36mm 3.5213 ^{29,104,123}	
2007-10	Torsion Bar Mount		3.1143	2007-10	Front Diff Mount		3.1154
NEW 2007-10	Hyper-Flex® System Complete Master Set- See pg. 25						3.18133

K2500 HD SILVERADO 4WD

2001-06	3.3185 ⁵⁸			3.2141	3.4150	36mm 3.5213 ²⁹ ₁₀₄	
2001-06	Hyper-Flex® System Complete Master Set- See pg. 25						3.18128

1/2 TON K10/K1500, 3/4 TON K20, 1 TON K30 4WD

1988-98	3.3134 ⁵⁷			3.2128	3.4121 ⁴² 3.4122 ⁷⁶ 3.4123	32mm 3.5136 ¹⁰⁴	9.13101 ⁷²
1981-87			3.2105 3.2112 ⁴⁰	See Chart Below	3.4116 3.4121 ⁷⁵	1 1/4" 3.5118 ¹²³	9.13119 ⁷²
1973-80			3.2105 3.2112 ⁴⁰	See Chart Below	3.4103 3.4140 ²⁰	1 1/16" 3.5179 ^{29,123} 1 1/4" 3.5180 ^{29,123}	9.13119 ⁷²
1971-72			3.2105 3.2112 ⁴⁰	3.2106	3.4107		9.13119 ⁷²
1967-70			3.2131	3.2106	3.4107		9.13119 ⁷²

1988-98	Chevy/GMC 4WD 1/2, 3/4 & 1 ton STD and Extra Cab Hyper-Flex® System Master Set- See pg. 25						3.18101
1981-87	Chevy/GMC 4WD 1/2 & 3/4 ton (w/stock front springs) Hyper-Flex® System Master Set- See pg. 25						3.18102
1981-87	Chevy/GMC 4WD 1/2 & 3/4 ton (w/aftermarket front springs) Hyper-Flex® System Master Set- See pg. 25						3.18103 ⁴⁰
1973-80	Chevy/GMC 4WD 1/2 & 3/4 ton (w/stock front springs) Hyper-Flex® System Master Set- See pg. 25						3.18104
1973-80	Chevy/GMC 4WD 1/2 & 3/4 ton (w/aftermarket front springs) Hyper-Flex® System Master Set- See pg. 25						3.18105 ⁴⁰
1971-87	Front Frame Shackle Eye Set 4-Bushings 2-Sleeves	3.2111	Various Years		Motor Mounts- See pgs. 16 thru 20	See Charts	
1988-98	Rear Spring- Frame Shackle Bushings Only	3.2139	1960-75		K10, K20, K30 Transfer Case Torque Arm Mount	3.1107	
1985-00	Transmission Mount (for automatic transmission)	3.1129	1968-84		K10, K20, K30	3.1106	
Various Years	Chevy/GMC Motor Mount Set		3.1156				

Leaf Spring Bushings- for 4WD Rear O.E.M. Springs
COMPLETE SET INCLUDES SHACKLE BUSHINGS) 12 BUSHINGS, 6 SLEEVES
 Whether you are adding new springs, throwing on a camper, or towing a trailer, Energy Suspension polyurethane spring bushings complete the package. Hyper-Flex® performance polyurethane leaf spring bushings allow the rest of the suspension to function properly.



Model	Description	Year	Complete Spring Bushing Set	Frame Shackle Eye Set
K10 Pickups and Blazers 4WD	With 1 1/2" O.D. Frame Shackle (1 1/2" Main Eye)	1967-87	3.2106	1 1/2" use 3.2124
	With 1 3/8" O.D. Frame Shackle (1 1/2" Main Eye)	1981-87	3.2108	1 3/8" use 3.2126
K20 4WD 1700-2800 lb. Axle Rating	With 1 1/2" O.D. Frame Shackle (1 1/2" Main Eye)	1973-87	3.2106	1 1/2" use 3.2124
	With 1 3/8" O.D. Frame Shackle (1 1/2" Main Eye)	1981-87	3.2108	1 3/8" use 3.2126
K20, K30 4WD 3000-3500 lb. Axle Rating	With 1 1/2" O.D. Frame Shackle (1 3/4" Main Eye)	1973-87	3.2107	1 1/2" use 3.2124
	With 1 3/8" O.D. Frame Shackle (1 3/4" Main Eye)	1981-87	3.2113	1 3/8" use 3.2126
K30 4WD 3950 lb. Axle Rating	With 1 1/2" O.D. Frame Shackle (1 3/4" Main Eye)	1981-87	3.2116	1 1/2" use 3.2124
	With 1 3/8" O.D. Frame Shackle (1 3/4" Main Eye)	1981-87	3.2117	1 3/8" use 3.2126
	With 1 3/4" O.D. Frame Shackle (1 3/4" Main Eye)	1973-87	3.2120	1 3/4" use 3.2125

FOOTNOTES: 20 1975-79 Crew cab only 29 Greaseable Frame Bushings 40 Aftermarket springs except Superlift and Skyjacker 42 1988-91 Crew cab only 57 Must reuse all metal parts 58 Uppers must reuse all hardware 72 2 boots per package- See page 13 for more information 75 Crew cab only 76 Extra cab only 104 Sway bar end links included 123 Includes sway bar end link bushings

Note: For product color add R for red or G for black after each part number.

ENERGYSUSPENSION.COM



DODGE & PLYMOUTH 2WD

Year	Front End Control Arm Bushing Set	Front Strut Rod Bushing Set	Rear Leaf Spring Bushing Set	Body (Cab) Mount Set	Complete Front Sway Bar Bushing Set	Complete Rear Sway Bar Bushing Set	Tie Rod Boots
------	-----------------------------------	-----------------------------	------------------------------	----------------------	-------------------------------------	------------------------------------	---------------

DAKOTA 2WD

1997-04	5.3122 ²		5.2113		28mm 5.5137 ¹²³ 30mm 5.5141 ¹²³	9/16" 5.5148 ^{29,123}	9.13119 ⁷²
1987-96	5.3115 ²		5.2107	5.4106 ⁸⁹	28mm 5.5118 ¹⁰⁴		See page 13
1987-96	Front Lower Bump Stop		5.6102	1987-96	Steering Rack Bushing Set (Manual or Power Steering)		5.10102

DURANGO 2WD

1998-03	5.3122 ²		5.2114				See page 13
---------	---------------------	--	--------	--	--	--	-------------

D-50 2WD

1979-93	5.3102 ⁸	5.7102	5.2103		7/8" 5.5101 ¹⁰⁴		9.13101 ⁷²
---------	---------------------	--------	--------	--	----------------------------	--	-----------------------

RAM 1500 2WD

2002-05	5.3137 ^{2 57}		5.2115		34mm 5.5159 ¹²³ 36mm 5.5160 ¹²³		
1994-01	5.3124 ²³		5.2109 ¹⁰⁰ 5.2111 ¹⁰⁵	5.4113 ¹⁴² 5.4112 ^{76,142}	30mm 5.5125 ^{29,104} 32mm 5.5124 ^{29,104}		9.13131 ⁷²
2002-05	Ram 1500 Hyper-Flex® System Complete Master Set- See pg. 25						5.18117
1994-01	Ram 1500 Hyper-Flex® System Complete Master Set- See pg. 25						5.18109 ¹⁰⁰
2002-05	Rack & Pinion Bushing Set		5.10103	2002-05	Front Bumpstop Set		5.6112
2002-05	Front Coil Spring Isolator Set		5.6111				

RAM 2500, 3500 2WD

1994-02	5.3124 ²³		5.2109 ¹⁰⁰ 5.2111 ¹⁰⁵ 5.2119 ¹⁴⁵	5.4113 ¹⁴² 5.4112 ^{76,142}	30mm 5.5125 ^{29,104} 32mm 5.5124 ^{29,104}		9.13131 ⁷²
1994-02	Ram 2500, 3500 2WD Hyper-Flex® System Complete Master Set- See pg. 25						5.18109

D100, 200, 300, RAMCHARGER 2WD

1972-93	5.3105 ⁵⁷ 5.3106 ^{57,91}	5.7104	5.2102 ^{38,62} SPRING ONLY	5.4101 ⁹² 5.4102 ⁹³	15/16" 5.5140 ^{29,123}		9.13101 ⁷²
1969-71			5.2102 ^{38,62} SPRING ONLY				9.13101 ⁷²

B100, B200, B300 VANS

1979-97	5.3110 ²	5.7103					9.13101 ⁷²
1976-78	5.3105 ⁵⁷ 5.3106 ^{57,91}	5.7103					9.13101 ⁷²
1970-75	5.3105 ⁵⁷ 5.3106 ^{57,91}	5.7104					9.13101 ⁷²

DODGE CARAVAN, PLYMOUTH VOYAGER, RAMPAGE (1982-84)

1984-90	5.3107 ^{57 66}	5.7107 ¹³			15/16" 5.5102 ¹²³ 1" 5.5103 ¹²³ 1 1/16" 5.5104 ¹²³ 1 1/8" 5.5105 ¹²³		See page 13
---------	-------------------------	----------------------	--	--	---	--	-------------

Performance Transmission Mount Set

Energy Suspension has re-engineered the Chrysler transmission mount using the highest quality polyurethane. This material is impervious to all under vehicle fluids and contaminants, including transmission fluid, oils, fuel, ozone, road salt, etc. The formulation of this super-tough material is firm enough for huge amounts of horsepower and torque, yet soft enough not to transmit vibration. The set includes two bushings with a plated sleeve and is designed to reuse original brackets.



Year	Model	Engine	Part Number
1972-87	D100, D200, D300, RAMCHARGER 2WD	225, 318, 360	5.1101
1972-78	W100, W200, W300, RAMCHARGER 4WD	225	5.1101
1982-87	B100, B200, B300	198, 225, 318, 360, 400, 440	5.1101
1979-81	B100, B200, B300	318, 360, 400, 440	5.1101
1969-78	B100, B200, B300	198, 225, 318, 360, 400	5.1101

FOOTNOTES: ² Must reuse existing outer metal shells ⁸ Lowers only ¹³ Included in front control arm bushing set ²³ Front lowers must reuse existing outer shells ²⁹ Greaseable Frame Bushings ³⁸ Does not include frame shackle bushings ⁵⁷ Must reuse all metal parts ⁶² 1" eye only ⁶⁶ Includes strut bushings ⁷² 2 boots per package— See page 13 for more information ⁷⁶ Extra cab only ⁸⁹ Standard cab only ⁹¹ With 4000 lb. rear axle ⁹² 1972-'85 pickup truck only ⁹³ Ramcharger only ¹⁰⁰ With 2 1/2" I.D. main eye & 2 1/2" wide spring ¹⁰⁴ Sway bar end links included ¹⁰⁵ With 1 3/4" I.D. main eye & 2 1/2" wide spring ¹²³ Sway bar end link bushings included ¹⁴² Includes hardware ¹⁴⁵ With 3" wide springs

Note: For product color add R for red or G for black after each part number.



DODGE & PLYMOUTH 4WD (cont.)

Dodge Cummins Motor Mount Inserts

HOLD YOUR HORSES!

Modified high horsepower-high torque Dodge diesel engines demand our performance polyurethane motor mount inserts. You will gain a dramatic increase in durability and a torque resistant feel you can't find anywhere else!



1994-02	Motor Mount Insert Set - Ram 2500 / 3500 2 & 4WD 5.9L Cummins Diesel. 12 valve.	5.1114
1994-02	Motor Mount Insert Set - Ram 2500 / 3500 2 & 4WD 5.9L Cummins Diesel. 24 valve.	5.1116

Year	Front End Control Arm Bushing Set	Front Track Rod Bushing Set	Rear Leaf Spring Bushing Set	Body (Cab) Mount Set	Complete Front Sway Bar Bushing Set	Complete Rear Sway Bar Bushing Set	Tie-Rod Boots
------	-----------------------------------	-----------------------------	------------------------------	----------------------	-------------------------------------	------------------------------------	---------------

DAKOTA 4WD

2000-04	5.3139		5.2113		35mm 5.5168 ¹²³	15mm 5.5167 ¹²³	
1997-99	5.3139		5.2113		33mm 5.5165 ¹²³	22mm 5.5166 ¹²³	
1987-96			5.2107				

2000-04	Front Rack & Pinion Bushing Set	5.10104 ⁵⁷
---------	---------------------------------	-----------------------

DURANGO 4WD

2000-03	5.3139		5.2114		35mm 5.5168 ¹²³	20mm 9.5152 no end links 15mm 5.5167 ¹²³	
1998-99	5.3139		5.2114		33mm 5.5165 ¹²³	22mm 5.5166 ¹²³	

2000-03	Front Rack & Pinion Bushing Set	5.10104 ⁵⁷
---------	---------------------------------	-----------------------

RAM 1500 4WD

1999-01	5.3131 ²	5.7111	5.2109 ¹⁰⁰ 5.2111 ¹⁰⁵	5.4112 ⁸⁹ 5.4112 ^{76,142}	32mm 5.5126 ^{29,123} 30mm 5.5127 ^{29,123}		9.13101 ⁷²
1994-98	5.3120 ²	5.7111	5.2109 ¹⁰⁰ 5.2111 ¹⁰⁵	5.4112 ^{76,89,142}	32mm 5.5126 ^{29,123} 30mm 5.5127 ^{29,123}		9.13101 ⁷²

RAM 1500 4WD MEGA CAB ONLY

NEW 2006-08	5.3142	5.7116 ¹⁴⁷	5.2118		32mm 5.5174 ¹²³		9.13130 ⁷²
2006-08	Front Axle Bump Stop Set	5.9105		2006-08	Rear Axle Bump Stop Set	5.9104	

RAM 2500, 3500 4WD

NEW 2006-09	5.3142	5.7116 ¹⁴⁷	5.2118		32mm 5.5174 ¹²³		9.13130 ⁷²
2003-05	5.3142	5.7116 ¹⁴⁷	5.2118	5.4115 ^{76,142} 5.4116 ¹⁴²	32mm 5.5174 ¹²³		9.13130 ⁷²

2003-09	Front Axle Bump Stop Set	5.9105		2003-09	Rear Axle Bump Stop Set	5.9104	
---------	--------------------------	--------	--	---------	-------------------------	--------	--

1999-02	5.3131 ²	5.7111	5.2109 ¹⁰⁰ 5.2111 ¹⁰⁵	5.4113 ¹⁴² 5.4112 ^{76,142}	32mm 5.5126 ^{29,123} 30mm 5.5127 ^{29,123}		9.13101 ⁷²
1994-98	5.3120 ²	5.7111	5.2109 ¹⁰⁰ 5.2111 ¹⁰⁵ 5.2119 ¹⁴⁵	5.4113 ¹⁴² 5.4112 ^{76,142}	32mm 5.5126 ^{29,123} 30mm 5.5127 ^{29,123}		9.13101 ⁷²

Year	Front End Control Arm Bushing Set	Front Strut Rod Bushing Set	Front Leaf Spring Bushing Set	Rear Leaf Spring Bushing Set	Body (Cab) Mount Set	Complete Front Sway Bar Bushing Set	Tie Rod Boots
------	-----------------------------------	-----------------------------	-------------------------------	------------------------------	----------------------	-------------------------------------	---------------

W100, 200, 300, RAMCHARGER 4WD

1972-93			5.2102 ^{38,62} SPRING ONLY	5.2102 ^{38,62} SPRING ONLY	5.4101 ⁹² 5.4102 ⁹³		9.13101 ⁷²
1969-71			5.2102 ^{38,62} SPRING ONLY	5.2102 ^{38,62} SPRING ONLY			9.13101 ⁷²

1972-93	Ramcharger 4WD Hyper-Flex® System Complete Master Set- See pg. 25						5.18101 ⁶²
---------	---	--	--	--	--	--	-----------------------

1972-85	STD Cab Pickup 4WD Hyper-Flex® System Complete Master Set- See pg. 25						5.18102 ⁶²
---------	---	--	--	--	--	--	-----------------------

FOOTNOTES: 2 Must reuse existing outer metal shells 29 Greaseable Frame Bushings 38 Does not include frame shackle bushings
 57 Must reuse all metal parts 62 1" eye only 72 2 Boots per package - See page for more information 76 Extra cab only
 89 Standard cab only 92 1972 thru '85 pickup truck only 93 Ramcharger only 100 With 2 1/2" I.D. main eye & 2 1/2" wide spring
 105 With 1 3/4" I.D. main eye & 2 1/2" wide spring 123 Includes Sway Bar End Link Bushings 142 Includes Hardware
 145 With 3" wide springs 147 Up to 3/18/2007



Note: For product color add R for red or G for black after each part number.

FORD, MERCURY & LINCOLN 2WD

Energy Suspension performance polyurethane bushings allow your suspension to travel throughout its full range without binding. If you have ever experienced a vehicle that wanders back and forth on the road, you may not know that worn and soft rubber bushings are a major contributor to this condition. We have reengineered the tracking arm, strut arm and C-bushings for a specific purpose. The axle pivot bushings utilize two separate polyurethane formulations, which pivot without binding. The C-bushings are specially formulated to maintain proper caster alignment and the track rod bushings prevent the entire front end from moving left to right. The result—instant response and better handling.



Hyper-Flex® System Master Set

TRUCKS

Year	Axle Pivot Bushing Set	Radius/Strut Arm Bushing Set	Front End Control Arm Bushing Set	Rear Leaf Spring Bushing Set	Body (Cab) Mount Set	Complete Front Sway Bar Bushing Set	Complete Rear Sway Bar Bushing Set	Tie Rod Boots
------	------------------------	------------------------------	-----------------------------------	------------------------------	----------------------	-------------------------------------	------------------------------------	---------------

EXPLORER 2WD & BRONCO II 2WD

1998-01			4.3157 ^{3,58}			34mm 4.5155 ¹²³		9.13101 ⁷²
1995-97			4.3157 ^{3,58}			36mm 4.5152 ¹²³	19mm 4.5153 ¹²³	9.13101 ⁷²
1991-94	4.3121 ²	4.7110		4.2124		.915" 4.5115 ¹²³	.615" 4.5116 ¹²³	9.13101 ⁷²
1984-90		4.7110		See page 67	4.4105 ¹¹⁶		See page 66	

1986-95	Transmission Mount		4.1148	1996-2001	Transmission Mount With V6 Only		4.1148
---------	--------------------	--	--------	-----------	---------------------------------	--	--------

RANGER 2WD

1998-11			4.3157 ^{3,58,128} 4.3168 ^{2,141,144}	4.2154	4.4117 ¹⁴²	27MM 4.5156 ¹⁰⁴		9.13101 ⁷²
1989-97	4.3119	4.7110		4.2134	4.4103	See page 66	See page 66	9.13101 ⁷²
1983-88	4.3119	4.7110		See page 67	4.4103	See page 66	See page 66	9.13101 ⁷²

1983-10	Transmission Mount		4.1148	1989-97	Rear Frame Shackle Bushing Set		4.2137
---------	--------------------	--	--------	---------	--------------------------------	--	--------

Year	Front End Control Arm Bushing Set	Rear End Control Arm Bushing Set	Rear Track Arm Bushing Set	Body (Cab) Mount Set	Complete Front Sway Bar Bushing Set	Complete Rear Sway Bar Bushing Set	Tie Rod Boots
------	-----------------------------------	----------------------------------	----------------------------	----------------------	-------------------------------------	------------------------------------	---------------

EXPEDITION 2WD & NAVIGATOR 2WD

1997-01		4.3146	4.7121	4.4111	32mm 4.5173 ¹⁰⁴	21mm 4.5151 ¹²³	9.13101 ⁷²
---------	--	--------	--------	--------	----------------------------	----------------------------	-----------------------

Year	Front End Control Arm Bushing Set	Axle Pivot Bushing Set	Radius/Strut Arm Bushing Set	Front Track Arm Bushing Set	Rear Leaf Spring Bushing Set	Body (Cab) Mount Set	Front Sway Bar Bushing Set	Tie Rod Boots
------	-----------------------------------	------------------------	------------------------------	-----------------------------	------------------------------	----------------------	----------------------------	---------------

F-100 & F-150 2WD

2004-06	4.3160 ²⁴				4.2151	4.4123	34mm 4.5185	
1997-03	4.3158 ^{2,58}				4.2150	4.4113 ⁸⁹ 4.4114 ³⁶ 4.4115 ⁷⁵	29mm 4.5147 ¹⁰⁴	9.13101 ⁷²
1993-96		4.3119 ²	4.7110		4.2122	4.4123 ¹⁴²	See page 66	9.13101 ⁷²
1987-92		4.3119 ²	4.7109		4.2122	4.4123 ¹⁴²	See page 66	9.13101 ⁷²
6/1983-86		4.3121 ²	4.7109		4.2122	4.4123 ¹⁴²	See page 66	9.13101 ⁷²
8/1981-5/83		4.3133	4.7109		4.2122	4.4123 ¹⁴²	See page 66	9.13101 ⁷²
1980-7/81		4.3121 ²	4.7109		See page 67	4.4123 ¹⁴²	See page 66	9.13101 ⁷²
1973-79		4.3124 ²	4.7107		4.2116	4.4104	See page 66	9.13101 ⁷²
1965-72		4.3124 ²	4.7107		See page 67		See page 66	9.13101 ⁷²

2004-06	Hyper-Flex® System Complete Master Set- See pg. 26			4.18125	1982-96	Rear Frame Shackle Bushing Set		4.2133
---------	--	--	--	---------	---------	--------------------------------	--	--------

1997-03	Hyper-Flex® System Complete Master Set- See pg. 26			4.18122	1973-81	Rear Frame Shackle Bushing Set		4.2129
---------	--	--	--	---------	---------	--------------------------------	--	--------

1997-03	Coil Lift Isolator Set 1", Front			4.6106				
---------	----------------------------------	--	--	--------	--	--	--	--

F-150 LIGHTNING 2WD

1999-04	4.3158 ^{2,58}				4.2150		31mm 4.5188 ¹²³	
---------	------------------------	--	--	--	--------	--	----------------------------	--

1999-04	Complete Rear Sway Bar Bushing Set		23mm 4.5189 ¹⁰⁴					
---------	------------------------------------	--	----------------------------	--	--	--	--	--

F-250 2WD & F-250 LIGHT DUTY 97-03 2WD

1997-03	4.3158 ^{2,58}				4.2150	4.4113 ⁸⁹ 4.4114 ³⁶ 4.4115 ⁷⁵	29mm 4.5147 ¹⁰⁴	9.13101 ⁷²
1993-96		4.3121 ²	4.7110		See page 67	4.4123 ¹⁴²	See page 66	9.13101 ⁷²
1990-92		4.3121 ²	4.7109		See page 67	4.4123 ¹⁴²	See page 66	9.13101 ⁷²
1987-89		4.3119 ^{2,6}	4.7109		See page 67	4.4123 ¹⁴²	See page 66	9.13101 ⁷²
1980-86		4.3121 ²	4.7109		See page 67	4.4123 ¹⁴²	See page 66	9.13101 ⁷²
1973-79		4.3119 ^{2,6} exc. HD	4.7107		See page 67	4.4104	See page 66	9.13101 ⁷²
1965-72		4.3119 ^{2,6} exc. HD	4.7107		See page 67		See page 66	9.13101 ⁷²

FOOTNOTES: 2 Must reuse existing outer metal shells 3 Lowers must use existing outer metal shells 6 With all round bushings 24 Uppers must reuse existing outer shells 36 2 door extended cab only 58 Uppers must reuse all hardware 72 2 boots per package- See page 13 for more information 75 Crew cab only 89 Standard cab only 104 Sway bar end links included 116 1983-88 only 123 Sway bar end link bushings included 128 With torsion bar front suspension 141 Must reuse existing inner sleeves & cap washers 142 Includes Hardware 144 With coil spring front suspension

Note: For product color add R for red or G for black after each part number.



FORD, MERCURY & LINCOLN 2WD (cont.)

Year	Front Leaf Spring Bushing Set	Axle Pivot Bushing Set	Radius/Strut Arm Bushing Set	Front Track Arm Bushing Set	Rear Leaf Spring Bushing Set	Body (Cab) Mount Set	Front Sway Bar Bushing Set	Tie Rod Boots
------	-------------------------------	------------------------	------------------------------	-----------------------------	------------------------------	----------------------	----------------------------	---------------

F-350 2WD

1999-04		4.3121 ²	4.7125		4.2147		29mm 4.5147 ¹²³	
1993-97		4.3121 ²	4.7110		See page 67	4.4123 ¹⁴²	See page 66	9.13101 ⁷²
1990-92		4.3121 ²	4.7109		See page 67	4.4123 ¹⁴²	See page 66	9.13101 ⁷²
1987-89		4.3119 ²	4.7109		See page 67	4.4123 ¹⁴²	See page 66	9.13101 ⁷²
1980-86		4.3121 ²	4.7109		See page 67	4.4123 ¹⁴²	See page 66	9.13101 ⁷²
1975-79		4.3124 ²	4.7107		See page 67	4.4104	See page 66	9.13101 ⁷²

F-350 & F-450 SUPER DUTY 2WD

1985-98	See page 67			4.7115	See page 67	4.4123 ¹⁴² F-350 only	See page 66	9.13101 ⁷²
---------	-------------	--	--	--------	-------------	----------------------------------	-------------	-----------------------

E-100, E-150, & E-200 (65-74) VAN 2WD

1975-01		4.3121 ²	4.7107					9.13101 ⁷²
1965-74		4.3124 ² with Twin I-Beam	4.7107					9.13101 ⁷²

E-250 AND E-350 VAN 2WD

1992-06		4.3121 ²	4.7107		4.2145		1" 4.5142 ¹²³	9.13101 ⁷²
1986-91		4.3121 ²	4.7107					9.13101 ⁷²
1966-85			4.7107					9.13101 ⁷²

1992-06	Econoline E250 & E350 Hyper-Flex® System Complete Master Set - See pg. 25							4.18116
---------	--	--	--	--	--	--	--	---------

1992-06	Front Sway Bar End Grommets	4.8101
---------	-----------------------------	--------

FORD, MERCURY & LINCOLN 4WD



C-Bushings, Radius/Strut Arm Bushings, Track Arm Bushings

Stock O.E.M. rubber C-Bushings are subject to the same deterioration problems as other rubber products. Additionally, they do not provide the correct geometry for coil spring Fords with lift equipment. This causes control problems associated with road wander. Energy Suspension C-Bushings are available in 2, 4 and 7 degree positive caster, for stock and altered suspension configurations. Maximum tensile strength has been engineered into all C-Bushings. Recommended usage for C-Bushings is 2° Offset for Stock to 2" lift, 4° Offset for 2" to 4" lift and the 7° Offset for more than a 4" lift.

Year	Axle Pivot Bushing Set	Radius/Strut Arm Bushing Set	Front Track Arm Bushing Set	C-Bushing Set	Complete 14 Piece Set	Rear Leaf Spring Bushing Set	Body (Cab) Mount Set	Tie Rod Boots
------	------------------------	------------------------------	-----------------------------	---------------	-----------------------	------------------------------	----------------------	---------------

BRONCO 4WD

2/1992-96	4.3133	4.7110				See page 67	4.4109	9.13101 ⁷²
1980-1/92	4.3133	4.7109				See page 67	4.4109	9.13101 ⁷²
1978-79		4.7107	4.7108	2° Offset 4.7101	2° Offset 4.7104	4.2103	4.4102	9.13101 ⁷²
1976-77		4.7107	4.7116 Oval	4° Offset 4.7102	4° Offset 4.7105	4.2102	4.4110 ¹³⁵	9.13101 ⁷²
1966-75		4.7107	4.7108	7° Offset 4.7103	7° Offset 4.7106	4.2102	4.4110 ¹³⁵	9.13101 ⁷²

1966-77	Hyper-Flex® System Complete Master Set (with 2 Degree C-Bushings) - See pg. 26							4.18104
---------	---	--	--	--	--	--	--	---------

1966-77	Hyper-Flex® System Complete Master Set (with 4 Degree C-Bushings) - See pg. 26							4.18105
---------	---	--	--	--	--	--	--	---------

1966-77	Tailgate Hinge Bracket and Bushing Set (2 brackets & bushings)							4.9102
---------	---	--	--	--	--	--	--	--------

1966-77	Bronco Transmission Mount Set	4.1101 ¹¹³	1966-77	Bronco Front Turn Signal Gasket	4.9101
---------	--------------------------------------	-----------------------	---------	--	--------

1966-96	Front or Rear Sway Bar Bushing Sets	See Page 66	1978-86	Bronco Spare Tire Bushing	4.9107
---------	--	-------------	---------	----------------------------------	--------

1978-79	Rear Frame Shackle Bushing Set (included in Spring Bushing Set) 4 Bushing & 2 Sleeves				4.2127
---------	--	--	--	--	--------

1966-77	Rear Frame Shackle Bushing Set (included in Spring Bushing Set) 4 Bushing & 2 Sleeves				4.2126
---------	--	--	--	--	--------

FOOTNOTES: 2 Must reuse existing outer metal shells 72 2 boots per package- See page 12 for more information

113 With manual transmission 123 Sway bar end link bushings included 135 For body mounts only use 4.4101, for hardware only use 4.4106

142 Includes Hardware

Note: For product color add R for red or G for black after each part number.

**Continued
Next Page**

FORD, MERCURY & LINCOLN 4WD (cont.)

Year	Axle Pivot Bushing Set	Radius/Strut Arm Bushing Set	Front End Control Arm Bushing Set	Rear Leaf Spring Bushing Set	Body (Cab) Mount Set	Complete Front Sway Bar Bushing Set	Complete Rear Sway Bar Bushing Set	Tie Rod Boots
------	------------------------	------------------------------	-----------------------------------	------------------------------	----------------------	-------------------------------------	------------------------------------	---------------

EXPLORER & BRONCO II 4WD

1998-01			4.3157 ^{3,58}			34mm 4.5155 ¹²³		9.13101 ⁷²
1995-97			4.3157 ^{3,58}			36mm 4.5152 ¹²³	19mm 4.5153 ¹²³	9.13101 ⁷²
1991-94	4.3133	4.7110		4.2124		.915" 4.5115 ¹²³	.615" 4.5116 ¹²³	9.13101 ⁷²
1984-90	4.3133	4.7110		See Page 67	4.4105	See Page 66	See Page 66	9.13101 ⁷²
1991-94	Explorer 4WD Hyper-Flex® System Complete Master Set- See pg. 25							4.18102
1986-90	Transmission Mount		4.1148	1996-01	Transmission Mount With V6 Only		4.1148	
1991-95	Transmission Mount		4.1148					

RANGER 4WD

1998-11			4.3157 ^{3,58}	4.2154	4.4117 ¹⁴²	29mm 4.5157 ¹⁰⁴		9.13101 ⁷²
1989-97	4.3133	4.7110		4.2134		See page 66	See page 66	9.13101 ⁷²
1983-88	4.3133	4.7110		See page 67	4.4103	See page 66	See page 66	9.13101 ⁷²
1989-97	Rear Frame Shackle Bushing Set (included in Spring Bushing Set) 4 Bushing & 2 Sleeves							4.2137
1983-10	Transmission Mount		4.1148					

Year	Front End Control Arm Bushing Set	Rear End Control Arm Bushing Set	Rear Track Arm Bushing Set	Body (Cab) Mount Set	Complete Front Sway Bar Bushing Set	Complete Rear Sway Bar Bushing Set	Tie Rod Boots
------	-----------------------------------	----------------------------------	----------------------------	----------------------	-------------------------------------	------------------------------------	---------------

EXPEDITION 4WD & NAVIGATOR 4WD

1997-01	4.3145 ²	4.3146	4.7121	4.4111	33mm 4.5145 ¹⁰⁴	22mm 4.5146 ¹²³	9.13101 ⁷²	
1997-01	Expedition 4WD & Navigator 4WD Hyper-Flex® System Complete Master Set- See pg. 25							4.18115

Year	Front Leaf Spring Bushing Set	Rear Leaf Spring Bushing Set	Front Track Arm Bushing Set	Front Sway Bar Frame Bushings	Body (Cab) Mount Set	Front Axle Bump Stop Set	Rear Axle Bump Stop Set
------	-------------------------------	------------------------------	-----------------------------	-------------------------------	----------------------	--------------------------	-------------------------

EXCURSION 4WD

2000-04	4.2148	4.2149	4.7126 ⁵⁷	36mm 4.5180		4.9103	9.9155	
2000-04	Hyper-Flex® System Complete Master Set- See pg. 25							4.18120
2000-04	Rear Overload Spring Snubber Set		9.9156					

Year	Axle Pivot Bushing Set	Radius/Strut Arm Bushing Set	Front Track Arm Bushing Set	C-Bushing Set	Complete 14 Piece Set	Rear Leaf Spring Bushing Set	Body (Cab) Mount Set	Tie Rod Boots
------	------------------------	------------------------------	-----------------------------	---------------	-----------------------	------------------------------	----------------------	---------------

F-100 & F-150 4WD 1966-96 (1997-06 - See Next Page)

1993-96	4.3133	4.7110				See page 67	4.4123 ¹⁴²	9.13101 ⁷²
1980-92	4.3133	4.7109				See page 67	4.4123 ¹⁴²	9.13101 ⁷²
1973-79		4.7107	4.7108	2° Offset 4.7101	2° Offset 4.7104	4.2103	4.4104	9.13101 ⁷²
1966-72		4.7107	4.7108	4° Offset 4.7102	4° Offset 4.7105	4.2102		9.13101 ⁷²
				7° Offset 4.7103	7° Offset 4.7106			
1980-96	Hyper-Flex® System Complete Master Set- See pg. 26							4.18101
1973-79	Hyper-Flex® System Complete Master Set with 2 Degree C-Bushings- See pg. 26							4.18106
1973-79	Hyper-Flex® System Complete Master Set with 4 Degree C-Bushings- See pg. 26							4.18107
1973-79	Rear Frame Shackle Bushing Set (included in Spring Bushing Set) 4 Bushing & 2 Sleeves							4.2127
1966-72	Rear Frame Shackle Bushing Set (included in Spring Bushing Set) 4 Bushing & 2 Sleeves							4.2126
1966-96	Front or Rear Sway Bar Bushings							See Page 66

FOOTNOTES: 2 Must reuse existing outer metal shells 3 Lowers must use existing outer metal shells 57 Must reuse all metal parts
58 Uppers must reuse all hardware 72 2 boots per package- See page 13 for more information 104 Sway bar end links included
123 Sway bar end link bushings included 142 Includes Hardware

Note: For product color add R for red or G for black after each part number.



FORD & LINCOLN 2WD & 4WD (cont.)

Year	Front End Control Arm Bushing Set	Front Leaf Spring Bushing Set	Axle Pivot Bushing Set	Front Track Arm Bushing Set	Rear Leaf Spring Bushing Set	Body (Cab) Mount Set	Complete Front Sway Bar Bushing Set	Tie Rod Boots
------	-----------------------------------	-------------------------------	------------------------	-----------------------------	------------------------------	----------------------	-------------------------------------	---------------

F-150 4WD & F-250 LIGHT DUTY 97-03 4WD

2004-06	4.3160 ²⁴				4.2151		34mm 4.5190	
1997-03	4.3145 ²				4.2150	4.4113 ⁸⁹ 4.4114 ³⁶ 4.4115 ⁷⁵	25mm 4.5172 ¹⁰⁴ 27mm 4.5154 ¹⁰⁴	9.13101 ⁷²

2004-06	Hyper-Flex® System Complete Master Set- See pg. 26						4.18125
---------	---	--	--	--	--	--	---------

1997-03	Hyper-Flex® System Complete Master Set- See pg. 26						4.18123
---------	---	--	--	--	--	--	---------

F-250 (SUPER DUTY 1999-07) 4WD

2005-07				4.7131 ¹⁴⁸	4.2147	4.4120 ^{57,75} 4.4121 ^{57,59}	13/16" 4.5196 ¹²³ 11/8" 4.5197 ¹²³	
1999-04		4.2148		4.7128	4.2147		11/4" 4.5186 ¹²³ 11/4" 4.5192 ^{123,131}	
1980-98		4.2121 w/2" I.D.	4.3133		See page 67	4.4123 ¹⁴²	See chart below	
1973-79		See page 67			See page 67	4.4104	See chart below	
1967-72		See page 67			See page 67		See chart below	

2005-07	Front Coil Spring Isolator Set	4.6111		2005-07	Rear Axle Bump Stop Set	4.9105
---------	---------------------------------------	--------	--	---------	--------------------------------	--------

2005-07	Front Axle Bump Stops	4.9104		1999-04	Front Frame Shackle Bushing Set	4.2152
---------	------------------------------	--------	--	---------	--	--------

2000-04	Hyper-Flex® System Complete Master Set- See pg. 26						4.18124
---------	---	--	--	--	--	--	---------

1999-04	Complete Rear Sway Bar Bushing Set	30mm 4.5187 ¹²³		1999-04	Rear Frame Shackle Bushing Set	4.2153
---------	---	----------------------------	--	---------	---------------------------------------	--------

1999-04	Front Axle Bump Stop Set	4.9103		1980-98	Front Frame Shackle Bushing Set	4.2131
---------	---------------------------------	--------	--	---------	--	--------

Sway Bar Bushing Sets- Front and Rear

- Dramatically improves handling characteristics
- Allows your truck's sway bars to work at 100% efficiency

F100, F150, F250, F350 2WD and 4WD Pickups, Bronco, Ranger, Bronco II, Explorer 2WD and 4WD (Except front sway bar mounted rear of axle) E100, E150, E200, E250 and E350

Specially formulated polyurethane bushings that will not mush out and distort like the original rubber. These sway bar bushings are designed to be used with existing mounting brackets.

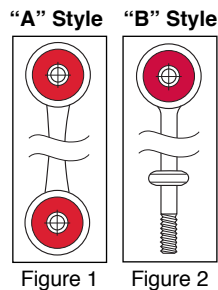
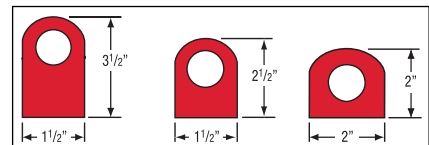

3 Steps To Determine The Correct Sway Bar Bushing Set

1. Identify end link type (A or B)—see Figure 1 or 2.
2. Measure height of Sway Bar Bushing—see Figure 3.
3. Measure sway bar diameter and choose the correct set from the chart below.

"A" Style Sets- Includes two sway bar bushings for O.E.M. brackets and eight bushings with four sleeves for end links.

Sway Bar Diameter	3 1/2" Tall Bushings	2 1/2" Tall Bushings	2" Tall Bushings
5/8"			4.5117
3/4"			4.5118
7/8"	4.5129	4.5105	4.5119
23mm	4.5115		
1"	4.5127	4.5106	4.5120
1 1/8"	4.5128	4.5107	4.5121

"B" Style Sets- Includes two sway bar bushings for existing brackets and four bushings with two sleeves for eye ends and four grommets for bayonet style end links.

Sway Bar Diameter	3 1/2" Tall Bushings	2 1/2" Tall Bushings	2" Tall Bushings
5/8"			4.5116
3/4"			4.5122
7/8"		4.5102	4.5123
1"		4.5103	4.5124
1 1/8"		4.5104	4.5125

FOOTNOTES: 2 Must reuse existing outer metal shells 24 Uppers must reuse existing outer shells 36 Extended cab only
 57 Must reuse all metal parts 59 Except crew cab 72 2 boots per package- See page 13 for more information 75 Crew cab only
 89 Standard cab only 104 Sway bar end links included 123 Sway bar end link bushings included 131 Made on or before 3/99
 142 Includes Hardware 148 Must remove factory metal shells

Note: For product color add R for red or G for black after each part number.

Continued
Next Page

FORD & LINCOLN 2WD & 4WD (cont.)

Year	Front End Control Arm Bushing Set	Front Leaf Spring Bushing Set	Axle Pivot Bushing Set	Front Track Arm Bushing Set	Rear Leaf Spring Bushing Set	Body (Cab) Mount Set	Complete Front Sway Bar Bushing Set	Tie Rod Boots
------	-----------------------------------	-------------------------------	------------------------	-----------------------------	------------------------------	----------------------	-------------------------------------	---------------

F-350 4WD

2005-07				4.7131 ¹⁴⁸	4.2147	4.4120 ^{57,75} 4.4121 ^{57,59}	^{13/16"} 4.5196 ¹²³ ^{1 1/8"} 4.5197 ¹²³	
1999-04		4.2148		4.7126	4.2147		^{1 1/4"} 4.5186 ¹²³ ^{1 1/4"} 4.5192 ^{123 131}	
1980-98		4.2121 w/2" I.D.	4.3133		See page 67	4.4123 ¹⁴²	^{1 1/8"} 4.5126 ¹²³	
1973-79					See page 67	4.4104	See chart page 66	

1985-98	Track Bar Bushing Set with Solid Axle	4.7115	1999-04	Front Frame Shackle Bushing Set	4.2152
1999-04	Front Axle Bump Stop Set	4.9103	2005-07	Front Coil Spring Isolator Set	4.6111
1999-04	Rear Frame Shackle Bushing Set	4.2153	2005-07	Rear Axle Bump Stop Set	4.9105
1980-98	Front Frame Shackle Bushing Set	4.2131			

Leaf Spring Bushings Complete Set Includes Shackle Bushings

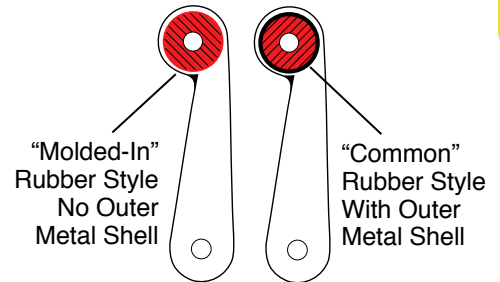
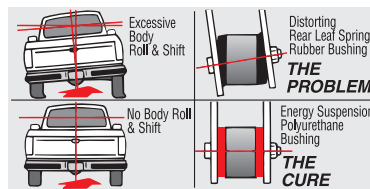

Model	Year	Complete Spring and Shackle Set	Frame Shackle Bushings
-------	------	---------------------------------	------------------------

FRONT

F250 (After Serial #Y20001) 4WD	1977-79	4.2120 ⁵⁹	4.2130
F250 (With 1 1/2" Main Eye O.D. & Before Serial #Y20001) 4WD	1973-77	4.2119 ⁵⁹	4.2130
F250 (With 1 1/4" Main Eye O.D.) 4WD	1967-77	4.2118	4.2130
F350 Super Duty (With 2" I.D. Springs) 2WD	1980-98	4.2121	4.2131
F450 (With 2" I.D. Spring) 2WD	1983-98	4.2142	4.2131
F450 2WD	1994-98	4.2146	N/A

REAR- 2WD

F150	1980-81	4.2116	4.2129
F100	1980-81	4.2117	4.2129
F100, F150 (With Three Bushing Shackle)	1968-72	4.2139	4.2143
F100, F150	1957-72	4.2113	4.2126
F250 Crew Cab (Spring Only) 2 1/2" Wide Spring	1973-79	4.2107 ³⁸	N/A
F250 3" Wide Spring	1973-79	4.2103 ⁵⁹	4.2127
F250 (With Three Bushing Shackle)	1968-72	4.2138	4.2143
F250, F350 (With "Molded-In" Frame Shackle Bushing)	1980-96	4.2140	4.2144
F250, F350 Except F350 Chassis Cab (With "Common" Frame Shackle Bushing)	1980-96	4.2114	4.2128
F350 Super Cab	1973-79		4.2132
F350 Except Super Cab (Spring Only)	1973-79	4.2107 ³⁸	N/A
Ranger (With "Molded-In" Frame Shackle Bushing)	1986-97	4.2134	4.2137
Ranger (With "Common" Frame Shackle Bushing)	1983-88	4.2117	4.2129
Ranger (With Plastic Frame Shackle Bushing)	1983-85	4.2122	4.2133

REAR- 4WD

Bronco II (With "Molded-In" Frame Shackle Bushing)	1986-90	4.2134	4.2137
Bronco II (With "Common" Frame Shackle Bushing)	1984-90	4.2117	4.2129
Bronco II (With Plastic Frame Shackle Bushing)	1984-90	4.2122	4.2133
F250 with 3" Wide Spring	1977-79	4.2103	4.2127
F250 Spring Only	1973-77	4.2107 ³⁸	N/A
Bronco, F150, 250, 350 (With "Common" Frame Shackle Bushing)	1980-96	4.2114	4.2128
Bronco, F150, 250, 350 (With "Molded-In" Frame Shackle Bushing)	1980-96	4.2140	4.2144
Ranger (With "Molded-In" Frame Shackle Bushing)	1986-97	4.2134	4.2137
Ranger (With "Common" Frame Shackle Bushing)	1983-88	4.2117	4.2129
Ranger (With Plastic Frame Shackle Bushing)	1983-85	4.2122	4.2133

FOOTNOTES: ³⁸ Does not include frame shackle bushings ⁵⁷ Must reuse all metal parts ⁵⁹ Except crew cab ⁷⁵ Crew cab only
¹²³ Sway bar end link bushings included ¹³¹ Made on or before 3/99 ¹⁴² Includes hardware ¹⁴⁸ Must remove factory metal shells

Note: For product color add R for red or G for black after each part number.



ISUZU

Year	Front End Control Arm Bushing Set	Rear End Control Arm Bushing Set	Front Leaf Spring Bushing Set	Rear Leaf Spring Bushing Set	Body (Cab) Mount Set	Complete Front Sway Bar Bushing Set	Tie Rod Boots
------	-----------------------------------	----------------------------------	-------------------------------	------------------------------	----------------------	-------------------------------------	---------------

AMIGO, RODEO

1989-95				14.2101		1 1/8" 14.5101 ¹⁰⁴	9.13101 ⁷²
---------	--	--	--	---------	--	-------------------------------	-----------------------

HOMBRE

1996-99	3.3162				3.4130 3.4131 ³⁶	1 1/8" 3.5185 ¹⁰⁴	9.13101 ⁷²
1996-99	Transmission Mount		3.1108	1996-99	Front Upper Bump Stop Set		3.9102
1996-99	Front Upper & Lower Coil Spring Isolators		3.6114				

TROOPER

7/1987-93				14.2102		1 1/8" 14.5101 ¹⁰⁴ 1987-91 only	9.13101 ⁷²
-----------	--	--	--	---------	--	---	-----------------------

JEEP

Year	Front End Control Arm Bushing Set	Front Track Arm Bushing Set	Rear End Control Arm Bushing Set	Rear Track Arm Bushing Set	Body (Cab) Mount Set	Complete Front Sway Bar Bushing Set	Complete Rear Sway Bar Bushing Set
------	-----------------------------------	-----------------------------	----------------------------------	----------------------------	----------------------	-------------------------------------	------------------------------------

WRANGLER JK

2007-14	2.3108 ²	2.7106	2.3109 ²	2.7107 ¹⁴⁸	2.4111 ^{139,142} 2.4109 ^{142,143}	31mm 2.5112 ¹²³	19mm 2.5113 ¹²³ 17mm 2.5114 ¹²³
---------	---------------------	--------	---------------------	-----------------------	--	----------------------------	--

NEW 2007-14	Hyper-Flex® System Complete Master Set 2 Door- See pg. 26						2.18109
--------------------	---	--	--	--	--	--	---------

NEW 2007-14	Hyper-Flex® System Complete Master Set 4 Door- See pg. 26						2.18108
--------------------	---	--	--	--	--	--	---------

2007-14	Body Mount Set 2 Door with 1" Intergrated Body Lift						2.4112 ¹⁴²
---------	---	--	--	--	--	--	-----------------------

2007-14	Body Mount Set 4 Door with 1" Intergrated Body Lift						2.4110 ¹⁴²
---------	---	--	--	--	--	--	-----------------------

2007-14	Front Bump Stop Set (OE height)	2.9101	2007-14	Rear Spring Isolator (1.75" Lift)	2.6112
---------	---------------------------------	--------	---------	-----------------------------------	--------

2007-14	Rear Bump Stop Set (OE height)	2.9103	2007-14	Rear Track Arm Bushing Set	2.7107 ¹⁴⁸
---------	--------------------------------	--------	---------	----------------------------	-----------------------

2007-14	Rear Sway Bar Bushing Set 17mm	2.5114 ¹²³	2007-14	Tailgate Tire Bumper	2.9105
---------	--------------------------------	-----------------------	---------	----------------------	--------

2007-14	Front Spring Isolator (1.75" Lift)	2.6111	2007-14	Bump Stop Set (Extended)	2.9106
---------	------------------------------------	--------	---------	--------------------------	--------

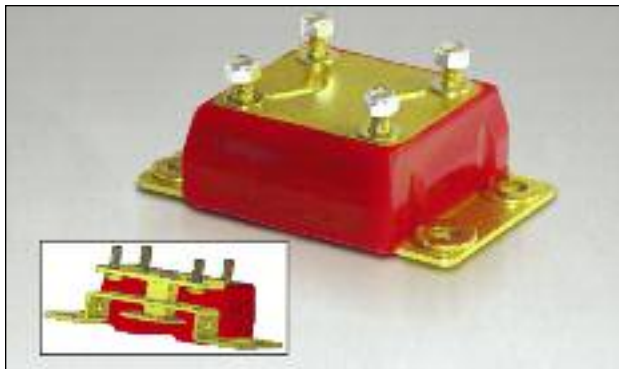

2.1103
TRANSMISSION MOUNT



2.1104
MOTOR MOUNT



2.6102
COIL LIFT ISOLATOR

FOOTNOTES: ² Must reuse existing outer metal shells ³⁶ Extended cab only ⁷² 2 boots per package- See page 12 for more information ¹⁰⁴ Sway bar end links included ¹²³ Includes sway bar end link bushings ¹³⁹ 2 door only ¹⁴² Includes hardware ¹⁴³ 4 door only ¹⁴⁸ Must remove factory metal shells

Note: For product color add R for red or G for black after each part number.

**Continued
Next Page**

JEEP (cont.)



Hyper-Flex® System Complete Master Set contains most of the part numbers listed below.

TRUCKS

Year	Front End Control Arm Bushing Set	Front Track Arm Bushing Set	Front Leaf Spring Bushing Set	Rear Control Arms	Rear Track Bar	Complete Front Sway Bar Bushing Set	Rear Swap Bar
------	-----------------------------------	-----------------------------	-------------------------------	-------------------	----------------	-------------------------------------	---------------

WRANGLER TJ

1997-06	2.3106 2	2.7102	2.3107 2	2.7103	2.4107 57	30mm 2.5110 29,123	16mm 2.5111 123
1997-06	Hyper-Flex® System Complete Master Set- See pg. 25						2.18107
1997-06	Hyper-Flex® System Complete Master Set w/ integrated 1" body lift kit - See pg. 25						2.18106
1997-06	Body Mount Set with 1" Body Lift (Complete w/Hardware)	2.4108	1997-06	Transmission Mount	2.1103		
1997-06	Front Bump Stop Set (OE height)	2.9101	1997-06	Coil Lift Isolator Set (Front or Rear 1.75" lift)	2.6102		
1997-06	Front Coil Spring Isolator Set (OE height)	2.6101	1997-06	Coil Lift Isolator Set (Front or Rear .75" lift)	2.6103		
1997-06	Rear Coil Spring Isolator Set (OE height)	2.6108	1997-06	Extended Front Bump Stop Set for 1 3/4" lift	2.9102		
1997-06	Motor Mount Set (2 Per Set) 6 Cyl.	2.1104 2	1997-06	Bump Stop Set - Ft w/ 1.75" Lift	2.9102		

WRANGLER YJ

1987-96	2.2107 2.2119 51	2.7101	2.2107 2.2119 51	2.7101	2.4105	15/16" 2.5102 123 1 1/8" 2.5107 123	9.13101 72
1987-96	Hyper-Flex® System Complete Master Set- See pg. 26						2.18101
1987-96	Motor Mount Set (2 Per Set) 6 Cyl.	2.1104 2	1987-96	Transmission Torque Arm Grommets (2)	2.1101		
1987-96	Transmission Mount	3.1108	1987-96	Front or Rear Frame Shackle Bushing Set (4)	2.2110, 2.2120 51		

CJ5, CJ7, CJ8 SCRAMBLER

1981-86			2.2102 2.2115 51	2.2103 2.2116 51	2.4104 83 2.4102	15/16" 2.5101 123	9.13101 72
1980			2.2102 2.2115 51	2.2103 2.2116 51	2.4102	15/16" 2.5101 123	9.13101 72
1976-79			2.2102 2.2115 51	2.2103 2.2116 51	2.4103	15/16" 2.5101 123	9.13101 72
1974-75			2.2101	2.2101	2.4106		9.13101 72
1955-73			2.2101	2.2101	2.4101 56		9.13101 72

1980-86	Hyper-Flex® System Complete Master Set- See pg. 25 (CJ5 & CJ7 Only)						2.18102
1976-79	Hyper-Flex® System Complete Master Set- See pg. 25						2.18103
1955-75	Hyper-Flex® System Complete Master Set- See pg. 25						2.18104
1976-86	Front Frame Shackle Bushing Set (4)	2.2105, 2.2118 51					
1976-86	Rear Frame Shackle Bushing Set (4)	2.2106, 2.2117 51					
1976-86	CJ5, CJ7 Front or Rear Bump Stop (2)	9.9137					
1972-86	CJ Series Transmission Mount - All	3.1108					
1973-86	Transmission Torque Arm Grommets (2)	2.1101					
1972-86	CJ Series Motor Mount (ea) 6 Cyl.	2.1102					

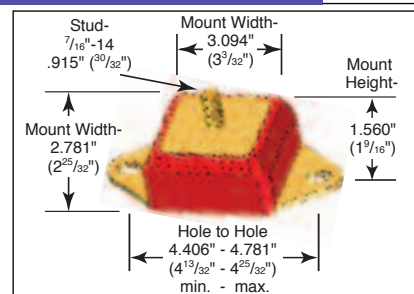

2.1102 Motor Mount

FOOTNOTES: 2 Must reuse existing outer metal shells 29 Greaseable Frame Bushings 51 With aftermarket shackles 56 14 piece set 57 Must reuse all metal parts 72 2 boots per package-See page 12 for more information 83 1981-86 CJ8 only 123 Includes sway bar end link bushings

Note: For product color add R for red or G for black after each part number.



J E E P (cont.)

Year	Front End Control Arm Bushing Set	Front Track Arm Bushing Set	Front Leaf Spring Bushing Set	Rear Leaf Spring Bushing Set	Body (Cab) Mount Set	Complete Front Sway Bar Bushing Set	Tie Rod Boots
------	-----------------------------------	-----------------------------	-------------------------------	------------------------------	----------------------	-------------------------------------	---------------

CHEROKEE, WAGONEER, COMANCHE (DOWNSIZE), XJ SERIES

1984-01	2.3102 2, 99 2.3101 2, 98			2.2109		23mm 2.5103 123 24mm 2.5104 123 25mm 2.5106 123 28mm 2.5105 123	9.13101 72
1984-01	Hyper-Flex® System Complete Master Set- See pg. 26						2.18105
1984-01	Cherokee Front Track Arm Bushing Set	2.7102		1984-01	Coil Lift Isolator Set (Front 1.75" Lift)	2.6102	
1986-92	Comanche Front Track Arm Bushing Set	2.7102		1984-01	Coil Lift Isolator Set (Front .75" Lift)	2.6103	
1984-01	Rear Frame Shackle Bushing Set	2.2111		1987-01	Motor Mount Set (2 Per Set) 6 Cyl.	2.1104 2	

GRAND CHEROKEE, ZJ SERIES

1993-98	2.3103 2	2.3104 2				1" 2.5108 123	9.13101 72
1993-98	Rear Sway Bar Bushing Set- (5/8")	2.5109		1993-98	Coil Lift Isolator Set (Front or Rear .75" Lift)	2.6103	
1993-98	Front Track Arm Bushing Set	2.7102		1993-98	Coil Lift Isolator Set (Front or Rear 1.75" Lift)	2.6102	
1993-98	Rear Track Arm Bushing Set	2.7103					

L E X U S

Year	Front End Control Arm Bushing Set	Rear End Control Arm Bushing Set	Rear Track Arm Bushing Set	Body (Cab) Mount Set	Front Sway Bar Bushing Set	Rear Sway Bar Bushing Set	Tie Rod Boots
------	-----------------------------------	----------------------------------	----------------------------	----------------------	----------------------------	---------------------------	---------------

GX470

2009	8.3128 57, 73	8.3129	8.7105				
2003-08	8.3128 57, 73	8.3129	8.7105		29mm 8.5135	17mm 8.5136 123	

M A Z D A

Year	Front End Control Arm Bushing Set	Rear Leaf Spring Bushing Set	Body (Cab) Mount Set	Axle Pivot Spring Bushing Set	Radius/Strut Arm Bushing Set	Complete Front Sway Bar Bushing Set	Complete Rear Sway Bar Bushing Set	Tie Rod Boots
------	-----------------------------------	------------------------------	----------------------	-------------------------------	------------------------------	-------------------------------------	------------------------------------	---------------

B-SERIES TRUCK 2WD

1998-10	4.3157 3,58,128 4.3168 2,141,144	4.2154	4.4117 142			27mm 4.5156 104		9.13101 72
1993-97		4.2134		4.3119	4.7110	See page 66	See page 66	9.13101 72
1994-10	Transmission Mount		4.1148					

B-SERIES TRUCK 4WD

1998-10	4.3157 3,58	4.2154	4.4117 142			29mm 4.5157 104		9.13101 72
1994-10	Transmission Mount		4.1148					

NAVAJO 2WD & 4WD

1991-94		4.2124		4.3121 2WD 4.3133 4WD	4.7110	.915" 4.5115 123	.615" 4.5116 123	9.13101 72
1991-94	Transmission Mount		4.1148					

FOOTNOTES: 2 Must reuse existing outer metal shells 3 Lowers must use existing outer metal shells

57 Must reuse all metal parts 58 Uppers must reuse all hardware 72 2 boots per package- See page 13 for more information

73 Lowers must reuse all metal parts 98 2 wheel drive 99 4 wheel drive 104 Sway bar end links included

123 Includes sway bar end link bushings 128 With torsion bar front suspension 141 Must reuse existing inner sleeves & cap washers

142 Includes hardware 144 With coil spring front suspension

Note: For product color add R for red or G for black after each part number.



MITSUBISHI

Year	Front End Control Arm Bushing Set	Front Strut Rod Bushing Set	Front Leaf Spring Bushing Set	Rear Leaf Spring Bushing Set	Body (Cab) Mount Set	Complete Front Sway Bar Bushing Set	Tie Rod Boots
2WD PICKUP							
1987-96	5.3102 8	5.7102		5.2103		7/8" 5.5101 104	9.13101 72

NISSAN/DATSUN

Year	Front End Control Arm Bushing Set	Front Strut Rod Bushing Set	Front Leaf Spring Bushing Set	Rear Leaf Spring Bushing Set	Complete Body (Cab) Mount Set	Complete Front Sway Bar Bushing Set	Tie Rod Boots
PATHFINDER 2WD & 4WD							
1987-95	7.3102 2	7.7106				24mm 7.5117 104	9.13101 72

720 & HARDBODY, PICKUP 2WD

1986 1/2-97	7.3102 2	7.7106		7.2103		23mm 7.5108 104	9.13101 72
1980-86	7.3101 2	7.7104		7.2101		21mm 7.5106 104	9.13101 72

720 & HARDBODY, PICKUP 4WD

1986 1/2-97	7.3102 2	7.7106		7.2102		20mm 7.5109 104	9.13101 72
1980-86	7.3101 2	7.7104		7.2101		21mm 7.5107 123	9.13101 72

SCOUT II

1972-81			6.2102	6.2102	6.4101		9.13101 72
1972-81	Front or Rear Frame Shackle Bushing Set		6.2103				

SUZUKI

SAMURAI

1985-95			1.2101 1.2102 51	1.2101 1.2102 51		7/8" 1.5101 123	9.13103 72
1986-95	Body Mount Set - Incl Hardware		1.4101 142	1986-95	Body Mount Set 1" Lift-Incl Hardware		1.4102 142

TOYOTA 2WD & 4WD



Hyper-Flex® Suspension Bushing Sets for the FJ Cruiser.



Year	Front End Control Arm Bushing Set	Rear End Control Arm Bushing Set	Rear Track Arm Bushing Set	Body (Cab) Mount Set	Front Sway Bar Bushing Set	Rear Sway Bar Bushing Set	Tie Rod Boots
------	-----------------------------------	----------------------------------	----------------------------	----------------------	----------------------------	---------------------------	---------------

FJ CRUISER

2007-09	8.3128 57, 73	8.3129	8.7105		29mm 8.5135	17mm 8.5136 123	
---------	---------------	--------	--------	--	-------------	-----------------	--

Year	Front End Control Arm Bushing Set	Rear End Control Arm Bushing Set	Front Leaf Spring Bushing Set	Rear Leaf Spring Bushing Set	Complete Body (Cab) Mount Set	Complete Front Sway Bar Bushing Set	Tie Rod Boots
------	-----------------------------------	----------------------------------	-------------------------------	------------------------------	-------------------------------	-------------------------------------	---------------

FJ40, FJ60 LANDCRUISER

1981-89			8.2106	8.2106			9.13101 72
1979-80			8.2105	8.2105			9.13101 72
1964-78			8.2105	8.2105	8.4104		9.13101 72
1958-63					8.4104		9.13101 72

1964-78	Hyper-Flex® System Complete Master Set - See pg. 26					8.18105	
---------	---	--	--	--	--	---------	--

FOOTNOTES: 2 Must reuse existing outer metal shells 8 Lower only 51 With aftermarket shackles 57 Must reuse all metal parts
72 2 boots per package- See page 13 for more information 73 Lower must reuse all metal parts 104 Sway bar end links included
123 Includes sway bar end link bushings 142 Includes hardware

Note: For product color add R for red or G for black after each part number.

Continued
Next Page



TOYOTA 2WD & 4WD

TRUCKS

Make your Toyota more rugged and reliable with Energy Suspension's full line of performance polyurethane components. With two decades of research, development and testing of 2WD & 4WD Toyota vehicles, Energy has produced components to enhance handling, performance and versatility of these popular trucks on or off-road!



Year	Front End Control Arm Bushing Set	Rear End Control Arm Bushing Set	Rear Track Arm Bushing Set	Body (Cab Mount Set)	Front Sway Bar Bushing Set	Rear Sway Bar Bushing Set	Tie Rod Boots
------	-----------------------------------	----------------------------------	----------------------------	----------------------	----------------------------	---------------------------	---------------

RAV 4

1996-98	8.3113	8.3114			25mm 9.5129		9.13101 72
1996-98	Rear Axle Bump Stop Set		9.9135	1996-98	Rear Coil Spring Isolator Set		9.6101

SEQUOIA 2 & 4WD

2001-07	Front Rack & Pinion Bushing Set		8.10104	1996-99	Body Cab Mount Set		8.4111
---------	---------------------------------	--	---------	---------	--------------------	--	--------

4 RUNNER 2 & 4WD

2009	8.3128 57, 73	8.3129	8.7105		29mm 8.5135		
2003-08	8.3128 57, 73	8.3129	8.7105		29mm 8.5135	17mm 8.5136 123	
NEW 2000-02	8.3132 (96-02)	8.3133 4WD only (98-02)	8.7106 ABS	8.4110 142	26mm 8.5141 123	19mm 8.5142 123	
2000-02	8.3132	8.3133	8.7106	8.4110			
1998-99	8.3132	8.3133	8.7106	8.4111			
1996-97	8.3132		8.7106	8.4111			
1990-95	8.3108 57	8.3107	8.7104		24mm 8.5114 123	18mm 8.5115 123	9.13101 72

2000-02	Hyper-Flex® Master Set- See pg. 26		8.18114	1996-09	Rear Shock Bushing Set		8.8102
---------	------------------------------------	--	---------	---------	------------------------	--	--------

1998-99	Hyper-Flex® Master Set		8.18116	1996-02	Front Bump Stop Set		8.9103
---------	------------------------	--	---------	---------	---------------------	--	--------

1990-95	Hyper-Flex® System Complete Master Set- See pg. 26						8.18103
---------	--	--	--	--	--	--	---------

NEW 1996-02	Front Rack & Pinion Bushing Set		8.10103	1996-09	Rear Bump Stops		8.9104
--------------------	---------------------------------	--	---------	---------	-----------------	--	--------

1996-02	Front Coil Spring Isolators		9.6104				
---------	-----------------------------	--	--------	--	--	--	--

Year	Front End Control Arm Bushing Set	Rear End Control Arm Bushing Set	Front Leaf Spring Bushing Set	Rear Leaf Spring Bushing Set	Complete Body (Cab) Mount Set	Complete Front Sway Bar Bushing Set	Tie Rod Boots
------	-----------------------------------	----------------------------------	-------------------------------	------------------------------	-------------------------------	-------------------------------------	---------------

1989	8.3108 57			8.2108		24mm 8.5106 104	9.13101 72
------	-----------	--	--	--------	--	-----------------	------------

1986-88	8.3104 7,57 8.3105 8,57			8.2103	8.4102	19mm 8.5101 123 23mm 8.5102 123	9.13101 72
---------	----------------------------	--	--	--------	--------	------------------------------------	------------

1984-85			8.2102	8.2103	8.4102	19mm 8.5101 123 23mm 8.5102 123	9.13101 72
---------	--	--	--------	--------	--------	------------------------------------	------------

1984-85	Front Frame Shackle Bushing Set 4 Bushings		8.2104	1984-85	Rear Frame Shackle Bushing Set 4 Bushings		8.2109
---------	--	--	--------	---------	---	--	--------

1984-85	Front Axle Torque Arm Bushing Set 4 Bushings		8.7101				
---------	--	--	--------	--	--	--	--

FOOTNOTES: 7 Uppers only 8 Lower only 57 Must reuse all metal parts 72 2 boots per package- See page 13 for more information
73 Lower must reuse all metal parts 104 Includes sway bar end link bushings 123 Includes Sway Bar End Link Bushings
142 Includes hardware

Note: For product color add R for red or G for black after each part number.



ENERGYSUSPENSION.COM

TOYOTA 2WD & 4WD

Year	Front End Control Arm Bushing Set	Front Strut Rod Bushing Set	Front Leaf Spring Bushing Set	Rear Leaf Spring Bushing Set	Complete Body (Cab) Mount Set	Complete Front Sway Bar Bushing Set	Tie Rod Boots
------	-----------------------------------	-----------------------------	-------------------------------	------------------------------	-------------------------------	-------------------------------------	---------------

PICKUP 2WD (EXCEPT T-100 & Tundra)

2001-04					8.4107		
1995-00					8.4103	25mm 8.5123 104	9.13101 72
1989-94	8.3106 57	8.7103		8.2107		23mm 8.5105 104 25mm 8.5104 104	9.13101 72
1984-88	8.3103 57	8.7103		8.2103		18mm 8.5103 104 25mm 8.5104 104	9.13101 72
1979-83	8.3102 57	8.7103		8.2101		18mm 8.5103 104 25mm 8.5104 104	9.13101 72

PICKUP 4WD (EXCEPT T-100 & Tundra)

2005-13	8.3128 23,24,73			8.2116	8.4109	30mm 8.5140	
2001-04	8.3115 2,73			8.2108	8.4107	26mm 8.5117 123 27mm 8.5118 123	9.13101 72
1995 ¹ / ₂ -00	8.3115 2,73			8.2108	8.4103	26mm 8.5117 123 27mm 8.5118 123	9.13101 72
1989-95	8.3108 57			8.2108	8.4103	24mm 8.5106 123	9.13101 72
1986-88	8.3104 7,57 8.3105 8,57			8.2103	8.4101	19mm 8.5101 123 23mm 8.5102 123	9.13101 72
1984-85			8.2102	8.2103	8.4101	19mm 8.5101 123 23mm 8.5102 123	9.13101 72
1979-83			8.2102	8.2101	8.4101	19mm 8.5101 123 23mm 8.5102 123	9.13101 72

2005-13	Hyper-Flex® System Complete Master Set - All 2 & 4 WD Models to Tacoma Master Set- See pg. 26						8.18113
---------	--	--	--	--	--	--	---------

2001-04	Hyper-Flex® System Complete Master Set- See pg. 26						8.18107
---------	---	--	--	--	--	--	---------

1995 ¹ / ₂ -00	Hyper-Flex® System Complete Master Set- See pg. 26						8.18104
--------------------------------------	---	--	--	--	--	--	---------

1989-95	Hyper-Flex® System Complete Master Set- See pg. 26						8.18101
---------	---	--	--	--	--	--	---------

1979-85	Hyper-Flex® System Complete Master Set- See pg. 26						8.18102
---------	---	--	--	--	--	--	---------

1989-95	Rear Frame Shackle Bushing Set-4 Bushings	8.2111	1995 ¹ / ₂ -04	Front Coil Spring Isolators	9.6104
1979-85	Front Frame Shackle Bushing Set-4 Bushings	8.2104	1979-85	Front Axle Torque Arm Bushing Set-4 Bushings, 2 Sleeves	8.7101
1979-88	Rear Frame Shackle Bushing Set-4 Bushings	8.2109	2005-13	Reg. Access & Dbl Cab - Bump Stop Set - Rear	8.9102
2001-04	Front Rack & Pinion Bushing Set	8.10103	2005-13	Rack & Pinion Bushing Set	8.10106
1995 ¹ / ₂ -00	Front Rack & Pinion Bushing Set	8.10101	2005-13	Reg. Access & Dbl Cab - Bump Stop Set - Front	8.9101

T-100 4WD

1993-98	8.3108 57			8.4105		
---------	-----------	--	--	--------	--	--

TUNDRA 2 & 4WD

2000-06	Front Rack & Pinion Bushing Set	8.10104	2007-14	Rack & Pinion Bushing Set	8.10107 148
---------	--	---------	---------	--------------------------------------	-------------

FOOTNOTES: 2 Must reuse existing outer metal shells 7 Uppers only 8 Lower only 23 Front lowers must reuse existing outer shells
24 Uppers must reuse existing outer shells 57 Must reuse all metal parts 72 2 boots per package- See page 13 for more information
73 Lower must reuse all metal parts 123 Includes Sway Bar End Link Bushings 148 Must remove factory metal shells

Note: For product color add R for red or G for black after each part number.



ENERGY SUSPENSION APPAREL

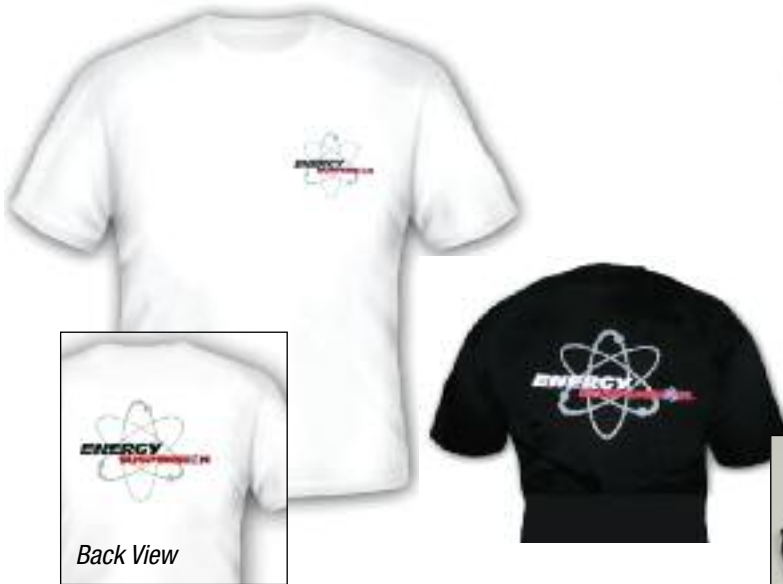

Back View

T-Shirt

100% pre-shrunk cotton. Energy Suspension logo silkscreened on left chest and on back.

Available in white or black.

Medium Black- #9.12109G

Medium White- #9.12109W

Large Black- #9.12110G

Large White- #9.12110W

X-Large Black- #9.12111G

X-Large White- #9.12111W

XXL-Black- #9.12112G

XXL-White- #9.12112W

3XL-Black- #9.12113G

3XL-White- #9.12113W

NEW Baseball Cap

100% organic cotton with Energy Suspension logo embroidered in red and white stitch. Medium-low profile crown. All black Flex-fit style hat.

#9.12143 (Large/XL)

#9.12144 (Small/Med)



Golf Shirt



100% combed cotton pique knit shirt. Embroidered with detailed Energy Suspension logo on left chest.

Available in tri-color putty/black or in black with red striped trim.

Medium Black- #9.12135G

Large Black- #9.12136G

X-Large Black- #9.12137G

XX-Large Black- #9.12138G

ACCESSORIES

Decals

Die Cut

Great for windows or any other place your customer wants to make the statement, "I have chosen the best."

These high quality vinyl decals are available in four sizes and four vibrant colors. Black-G, Red-R, White-W and Yellow-Y.

9" x 1 1/2"- #9.20106 12" x 1 7/8"- #9.20107 17" x 2 3/4"- #9.20104 24" x 3 3/4"- #9.20105



Tablet/Smartphone Holder

This handy unit is perfect for your desk or workspace. Branded with Energy Suspension logo to show you're a fan.

#9.9540



Large and Small Display Banners

Show your customers you use the best when it comes to polyurethane components. Energy Suspension 4-color print vinyl banners say it loud and proud. Available in 2 sizes.

36" x 12"- #9.20103

70" x 30"- #9.20125



NEW

Contingency Decal

2 1/2" x 9" 3 color vinyl.

#9.20108Y

Decals Die Cut

Apply to smaller vehicle areas, such as back and side windows, lower fenders, etc.

Each sheet has 1 med. & 1 small decal per sheet.



Available in two color combinations: white & black or red & black.

Sheet Size: 3 1/2" x 6 3/4"

White w/outline- #9.20109W

Red & Black- #9.20109G





The Amazing Easy-Gliding Wheel System **HYPER-glide™**



Made of superior formulation Hyper-Flex® polyurethane and uses high precision bearings. Experience little or no rolling resistance! The unique polyurethane material and design allows smooth, unimpeded rolling for indoor/outdoor ease of movement—over cracks, washers, misc. debris, etc.

- Fits Most Standard Caster Assemblies.
- Available in red or black with Cool Side Graphics.
- Rides on precision ABEC high quality bearings.
- Installs in a few minutes with two 5/32" hex wrenches (not included).
- All hardware is included.

- **Automotive-Type Creepers**
 - **Shop Stools**
- **Sit-Down Creeper Seats**
- **Shop Test Equipment**



Check Out
www.creeperwheels.com

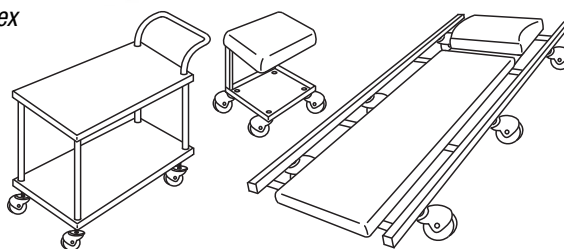

Use them for: auto mechanic creepers, stools, test equipment, parts stands & carts, and many other devices that use a rolling caster assembly.

(Note- Recommended maximum weight per wheel is 125 lbs.)



Part #	Wheel Size	# Of Wheels In Set
POLYCREEPER WHEELS		
9.9169	2"	4
9.9170	2"	6
9.9171	2.375"	4
9.9172	2.375"	6

Add- **R** For Red or **G** For Black Wheels

Energy Suspension's **POWER BAND**

OUTSTRETCHES RUBBER · IMPERVIOUS TO CHEMICALS & CONTAMINANTS · WILL NOT ROT



The Energy "Power Band" tie down straps are designed to be elastic enough to stretch easily to holding points. Each size band was engineered for its own length requirements. The wrong degree of elasticity will pull eyelets from tarps, damage goods and require the strength of an Olympic power lifter to use. This means a shorter band requires a thinner band of material.

Initially we tested the bands with standard "S" hooks. The steel "S" hooks straightened out before the Power Band finally separated. Special holding fixtures had to be made to test for the breaking point. Our 24 inch Power Band actually stretched to ten feet, seven inches before separating. The 31 inch band stretches to 13 feet! These are not practical usage numbers, but it does show the incredible elastic strength of our material. We also decided to use a full 3/16 inch diameter stainless steel for our "S" hooks. This adds strength and helps protect against corrosion.

Remember . . . only rich people can afford to buy rubber tie down straps... again and again and again.

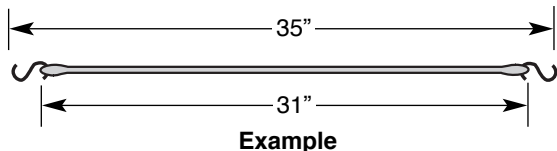

PART #: 12" Long **9.9012** 24" Long **9.9024**
18" Long **9.9018** 31" Long **9.9031**

Note: For product color add R for red or G for black after each part number.

