

**For more information, see [www.cranecams.com](http://www.cranecams.com)**

**READ CAREFULLY AND COMPLETELY BEFORE ATTEMPTING TO INSTALL THIS CAMSHAFT.**

**WARNING: NEW LIFTERS MUST BE  
INSTALLED WITH YOUR NEW CAMSHAFT.**

The camshaft and lifters must be pre-lubricated before installation. Use Crane Cams Assembly Lube, part number 99002-1, and Crane Cams Super-Lube, part number 99003-1

### CRANE CAMSHAFT INSTALLATION INSTRUCTIONS

The pictures shown in these instructions are for a small block Chevrolet. Check your engine manual for timing mark alignment for other engines.

1. Disconnect the battery, drain the cooling system, and remove the radiator. Remove all accessories necessary to make the cam, lifters, and timing chain accessible. Rotate the crankshaft slowly until the timing marks are aligned as shown in Figure 1.



**Figure 1.** Turn the engine over by hand to align timing marks. Check a shop manual for exact alignment.

2. Remove the camshaft timing sprocket as shown in Figure 2, and the timing chain. Re-install the cam sprocket and slowly remove the camshaft from the block. Excessive force is not required. If the camshaft can't be removed easily, stop and look for the obstruction. (Such as lifters, fuel pump rod, distributor gears, etc.)
3. **Clean the new cam with mineral spirits, or equivalent solvent.** Temporarily install the cam sprocket on your new Crane cam. Then, using Crane Assembly Lube, part num-



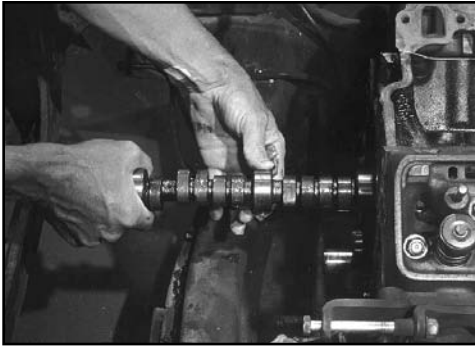
**Figure 2.** Loosen cam sprocket bolts and remove them. Place in a container and label or tag for later re-use.

ber 99002-1, coat all of the lobes and distributor gear (Figure 3). Lubricate the bearing journals using SAE 30 wt. oil. It is also highly recommended that you pour a bottle of Crane Cams Super Lube, part number 99003-1 into the engine to further fortify the initial break-in oil. We do not recommend the use of synthetic oils or other additives with our cams and lifters during break-in.

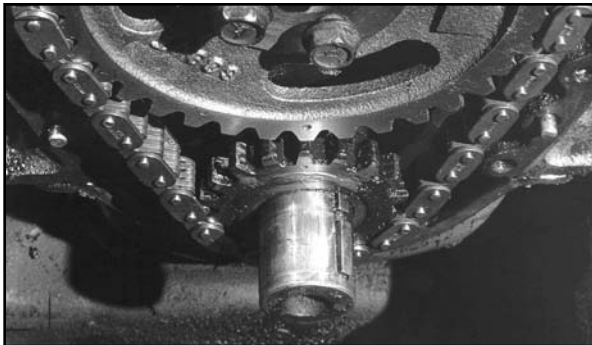


**Figure 3.** Apply lots of assembly lube to each cam lobe as shown.

4. Carefully slide your cam into the block. (Figure 4)
5. Remove the cam sprocket, install a new Crane chain, and bolt the assembly in place. Check the timing mark alignment (Figure 5) or your engine manual. Tighten the cam sprocket retaining bolts to correct torque specifications. (Figure 6) This is very important as most cam damage is caused by the cam gear coming loose due to improperly torqued bolts or worn keys and keyways. If the gear



**Figure 4.** Be sure not to wipe away any of the assembly lube as you install the cam into the block. Some motor oil on each cam bearing journal also helps make this step easier.



**Figure 5.** Timing marks must be exactly lined up. Our small block Chevy has a "dot over dot" arrangement, as shown. Consult your shop manual for exact arrangement of your engine.



**Figure 6.** When the timing marks have been correctly aligned (check and re-check this before proceeding!) you can re-install the cam sprocket bolts. Use a vibration-dampening adhesive, such as Loctite compound. Torque each bolt to factory specs.

loosens, the cam will slide back into the block causing the lifters to hit the adjacent lobes and bearing journals. **Proper torque and locking material should be applied to the threads for camshafts with only one bolt.** Cam gears with three bolts should have bolt heads drilled and safety wired. A camshaft bolt locking plate, part number 99168-1, is recommended for Chevrolet 262-400 and 396-454 cubic inch engines. (Figure 7)

Several cams require a plate that bolts to the block with a spacer between the cam gear and the front cam bearing journal. Some replacement gears have the spacer made on the gear. If so, make sure the original spacer is not used. To check gear alignment, put a straightedge across the timing gears from top to bottom. To verify that you



**Figure 7.** Crane Cams offers this unique camshaft locking plate and bolt kit for both small and big block Chevy's. It has tabs that can be bent over to prevent cam bolts from working loose. Good "insurance".

have the correct spacer to cam gear combination, check that the camshaft end play is .004" to .008". (This procedure is for engines with cam retaining plates only.)

Note: Many 1972 and later Ford-Mercury V-8 engines are originally equipped with a retarded crankshaft sprocket. This may cause idling and performance problems when installing aftermarket camshafts. Eliminate this problem by installing a pre-1972 crankshaft sprocket, (the non-retarded sprocket will have the alignment dot and keyway slot directly in line with each other), or by degreasing in your camshaft, or with appropriate Crane timing chain and gear set.

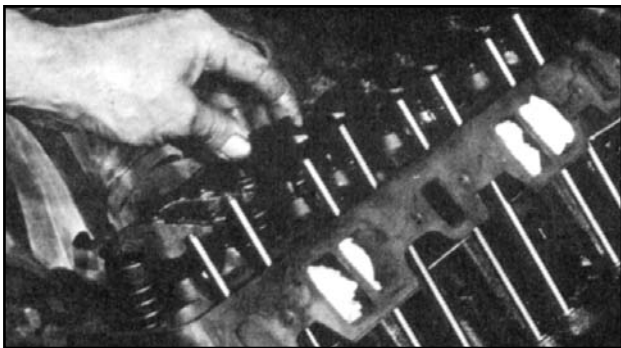
- To help prevent premature lobe wear, **new lifters must be installed** with this new camshaft. (No matter how little running time is on the "old" lifters.) O.E.M. lifters are acceptable, but we recommend new Crane performance lifters for maximum reliability. Coat the bottom of all lifters with Crane Assembly Lube, part number 99002-1, and place them into the lifter bores. (Figure 8)



**Figure 8.** Apply a generous amount of assembly lube to each lifter bottom.

- If cylinder head machining capabilities are not available or desired, and stock springs and retainers are used, make certain spring travel from assembled height to coil bind is a minimum of .060" more than the gross lift of the cam. Check with your Crane dealer for available Valve Spring and Retainer Kits that use stock diameter springs and require no head machining.

8. As a general rule, any cam with the same, or less, lift than any of our milder series cams for any given engine, should have a safe amount of piston to valve clearance if the engine, piston, cylinder head combination is stock. When using cams with higher lift, or engines with internal engine modifications to pistons and/or cylinder heads to increase compression, piston to valve clearance must be checked. Check with modeling clay when assembling the engine. Minimum clearance is .080" intake and .100" exhaust.
9. On engines with separate adjustable rocker arms such as small block Chevrolet, we recommend installing the pushrods and rocker arms on one cylinder at a time and adjusting the valves on that particular cylinder. Do not tighten the adjusting nut down before adjusting the valves. (Figure 9) If the adjustment is too tight this will cause the valve to hit the piston when you turn the engine over, resulting in bent valves, bent or broken pushrods, rocker arm studs to be pulled out of the head, and premature cam wear. On engines with shaft mounted adjustable rocker arms, back off all adjusters all the way before installing the assembly.

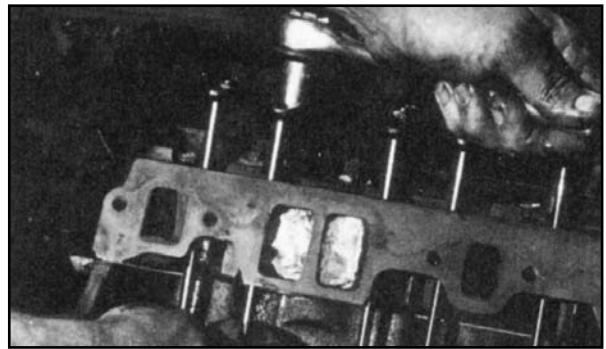


**Figure 9.** Install the rocker arms carefully, making sure that everything is in place and seated properly. Run the adjusting nuts down just enough to keep everything in place. **DO NOT TIGHTEN THEM BEFORE ADJUSTING THE VALVES!**

Make sure the pushrod is in the tappet and in the rocker arm seat when making valve adjustments.

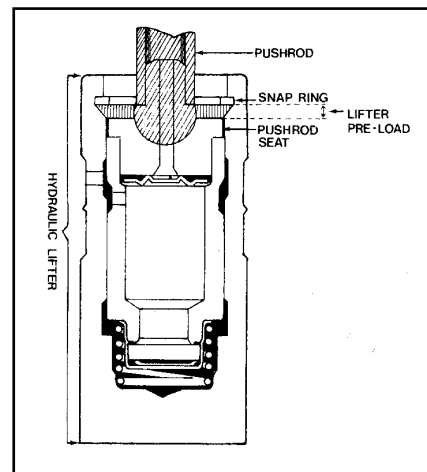
For hydraulic lifter camshaft valve adjustment, turn the engine in the normal direction of rotation until the exhaust lifter on the cylinder that you're adjusting starts to move up, then adjust the intake valve on that cylinder to zero lash with no preload, then 1/2 to 1 full turn more. Turn the engine over again until the intake lifter has come to full lift and then is almost all the way back down. Now, set the exhaust valve to zero lash, then 1/2 to 1 full turn more. Continue the above procedure for each cylinder until all valves are adjusted the same. (Figure 10)

This procedure will give you the correct lifter preload for any hydraulic lifter cam with adjustable rocker arms. If your engine has non-adjustable rocker arms, a lifter preload of .020" to .060" must be maintained. (Figure 11) Use the adjusting sequence as above to insure that the lifter is on the heel of the cam when preload is measured. Generally, pushrods for each cylinder should be the same unless valve stem heights are not correctly matched. When checking lifter preload make sure the valve is not



**Figure 10.** Valve lash adjustment can be easily and accurately performed by following the steps outlined in the text. Be absolutely sure of each valve before you go on to the next one.

open on the one you are checking. You may need to wait a few minutes for the lifter to bleed down. It may be necessary to change pushrod length, use adjustable pushrods, shim rocker stands or shafts, install straight screw-in studs in place of stock bottleneck type, use allen set adjusting nuts, or machine the cylinder heads for adjustable rocker arms, studs and guideplates. Part number 99170-1, Rocker Arm Pedestal Shim Kit is available for many Ford engines with pedestal mounted rocker arms. Detailed, easy to follow instructions on correctly checking for proper lifter preload can be found elsewhere in this brochure. See "The Fast and Easy Way to Check Lifter Preload".



**Figure 11.** Lifter preload is the distance between the pushrod seat in the lifter and the snap ring, when the lifter is on the heel of the cam and the valve is closed.

If the adjustment procedures are followed correctly for hydraulic lifter cams, no further adjustment is necessary for the life of the cam.

The same basic adjustment procedure should be used for mechanical lifter cams. Instead of lifter preload, you must use the clearance specs on the cam card for your cam. Mechanical lifter cams require a second adjustment after break-in, then periodically at tune-up time for the life of the cam.

10. Clean all parts and gasket surfaces, install new gaskets and re-assemble the engine. (Figure 12)
11. Rotate the crankshaft until the number one cylinder is





**Figure 12.** A silicon sealant (fast curing) should be used on end-rails as shown. This prevents annoying oil leaks. Do it right the first time and forget it!

coming up the compression stroke, and then align the timing mark on the damper with the recommended factory initial timing setting. On the compression stroke, both valves will be closed. Install the distributor with rotor pointing to #1 cylinder spark plug wire in the cap.

12. Use SE, SF, SG grade, or racing oil and add an 8 oz. Bottle of Crane Super Lube, part number 99003-1, for initial break-in. Fill the new oil filter with oil before installing it.
13. **IMPORTANT!** Don't allow the engine to run at less than 1500 RPM during the first half-hour of operation. Slow engine speeds invite premature cam and lifter wear and may cause their ultimate failure. **Change RPM frequently to direct oil splash to different areas of the camshaft. Vehicle may also be driven during break-in period.**
14. After the first hour or 100 miles of operation, change the oil and filter and re-adjust the valves (if mechanical lifters). Adjust them while the engine is warm.

Some aids to help set lifter preload on non-adjustable rocker arm equipped engines are part number 99170-1 Rocker Arm Pedestal Shim Kit for Ford engines with pedestal mounted rocker arms. Part number 99179-1 Rocker Arm Bridge Shim Kit is for Oldsmobile and some AMC V-8 and 6 cylinder engines with pivot bridge mounted rocker arms.

If you don't understand these instructions, please feel free to contact one of our Technical Consultants.

## THE FAST AND EASY WAY TO CHECK HYDRAULIC LIFTER PRELOAD

One of the most important steps in hydraulic camshaft installation is checking the lifter preload. This is the distance that the pushrod has extended into the lifter and depressed the pushrod seat from its retaining ring. Accurately checking that

this amount is correct (usually about a minimum of .020" to a maximum of .060") is critical to engine operation and life of the cam lobes, lifters and the engine's valve train itself. If your engine has too little, or no, lifter preload, the valve train will be very noisy when the engine is running. If your engine has too much lifter preload, it may idle roughly, have low manifold vacuum and poor low-end performance and may stall when put into gear.

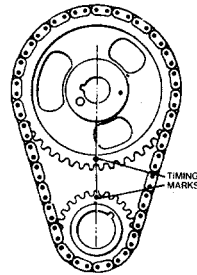
The most accurate method of checking lifter preload is by use of a dial indicator, but if you don't have a dial indicator, or don't know how to use one, there's an easy way that will work just as well.

Follow the instructions in your repair manual and torque all the bolts in their proper sequence. You'll be ready to check lifter preload when you reach the step where you're ready to adjust the valve lash.

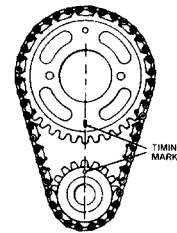
First, allow a couple of minutes for the lifter to bleed-down after you have placed some preload on it. This bleed-down period must be allowed to remove any of the oil that the lifter may have inside.

## VALVE TIMING MARKS

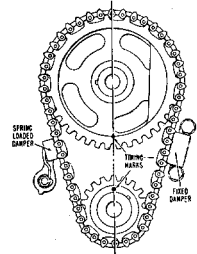
The valve timing marks shown are for camshaft installation use only and are not to be used for installing the distributor. See step 10 for distributor installation.



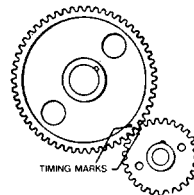
AMERICAN MOTORS V8



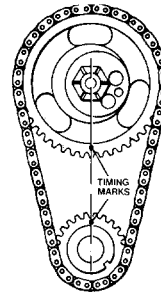
BUICK & BUICK SPECIAL  
V8-350, 400, 430, V8-455



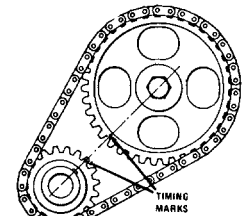
BUICK, OLDS V6



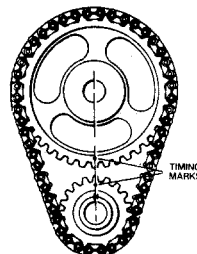
CHEVROLET SIX  
CHEVROLET LINE FOUR & SIX  
BUICK SPECIAL, 6-250  
OLDS F-85, 6-250  
PONTIAC TEMPEST, 6-250



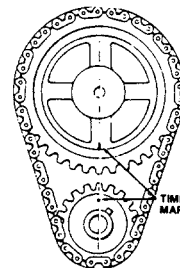
CHRYSLER LINE V8



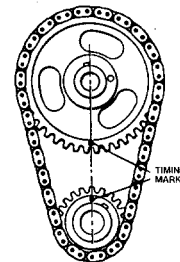
FORD 6-144, 170, 200, 250



FORD LINE V8



CADILLAC SEVILLE V8-350  
OLDS BUILT V8-260, 307  
OLDS LINE 1975-76 V8-350 & 455  
OLDS BUILT 1977-79 V8-350 V.I.N.  
CODE R & V8-403 V.I.N. CODE K



PONTIAC  
FIREBIRD & TEMPEST V8

Many new lifters (you must use new lifters with any new cam installation) come with some amount of oil in them, and you should allow one or two minutes for the bleed-down to occur.

Using the valve cover gasket surface of the cylinder head as a guide, lay a marking implement (metal scribe, etc.) flat on the reference guide. You'll be making two marks, so be sure your guide is flat and easily accessible. Now scribe a line on the pushrod.

Next unbolt the rocker assembly and loosen the bolts so that the pushrod will stand free in the pushrod seat of the lifter. You'll also note that the pushrod seat in the lifter will be forced up against the snap ring in the top of the lifter by the plunger spring in the lifter.

Now scribe another mark on the pushrod. You'll now have two marks on the pushrod. The difference between the two marks is the amount of travel that the pushrod made into the lifter, or the lifter preload.

You should maintain a minimum of .020" to a maximum of .060" lifter preload. In most installations you'll normally find that you should have either the correct amount of preload or too much preload. You can correct excessive lifter preload by shimming up a bridge-mount assembly by using Crane Cams' 99179-1 Rocker Arm Shim Kit.

Should you find that you have too little lifter preload, or you have free-play between the rocker arm and pushrod, you can also remedy this problem. Simply measure the amount of free-play between rocker arm and pushrod and then add .030" to this figure. This will allow you to buy new Crane pushrods in "longer than stock" length, or the stock length plus that amount you've measured out. Don't forget to add the .030" extra to allow the extra length needed to finally get the amount of preload that you were after in the first place. We can make pushrods to any length, but your measurements must be accurate, so check your measurements several times to be sure.

Normally, you'll only need to check two pushrods per cylinder head, one each intake and exhaust. However, if the valve stem heights of all the valves in the head are uneven (measure from the spring seat to top of the valve) or different from factory specs (found in your manual) then it will be necessary to check lifter preload on each valve.

If you're having a valve job done on your head(s), you can ask the machinist to check valve stem height for you. This is actually a normal part of a properly done performance job, but you might want to ask anyway. The end result will allow you to lay a straightedge across all the valve stems on the assembled head and have valve stem height check the same across the stems.

On other engines, which have individual studs, shoulder bolts or pedestals (such as the 151 cu. in Pontiac 4 cylinder) it is still relatively easy to check lifter preload quick and easy. For those engines that have bottleneck type studs, we have special adjusting nuts that simplify the preload checking process. This type of stud has a shoulder that is larger than the thread and the adjustment nut is tightened down to the shoulder, thus eliminating any adjustment. Special adjusting nuts are tubular in design with an allen head set screws in the top. These nuts are also counterbored at

the bottom so that they actually fit over the shoulder part of the stud.

These special adjusting nuts allow you to achieve the proper lifter preload as previously outlined. Tighten the adjusting nut down until you reach zero lash (no preload and no lash), then tighten it 1/2 to 1 turn more. Hold the nut with an end wrench and tighten the allen head set screw tight against the top of the stud. Continue this process until all of the valves have been adjusted.

On engines with pedestal or shoulder bolt mounted rocker arms you can use shims under the pedestal or shoulder to reduce the preload. If preload is too little, or there's none at all, you'll need to have longer than stock pushrods made. Use the same procedure outlined earlier to determine lifter preload and the amount longer your pushrods must be.

On engines that have individually mounted rocker arms, you should be able to achieve correct lifter preload by first tightening the adjusting nut or bolt down to zero lash. Now torque into place the adjusting nut or bolt by tightening 3/4 to 1 full turn of torque wrench rotation. This should place the pushrod at the correct lifter preload point. If for some reason you cannot achieve the correct lifter preload (.020" to .060") with 3/4 to 1 full turn tighter, then you'll have to follow the instructions outlined earlier and use the appropriate shim kit or longer than stock pushrods.

If you do not understand the previously mentioned steps, or you have additional problems: Stop before you make a mistake that will damage your new cam or valve train, and call one of our Technical Consultants.

## TROUBLESHOOTING GUIDE

### Adjust valve lash properly

All engines have a means for changing their valve lash. Be sure and follow the instructions included with the cam, lifters, or rocker arms. Take the extra time required to check the items mentioned before you fire up the engine.

### Check for rocker arm interference

Installing a Crane performance camshaft usually means that you are increasing the maximum valve lift over that the stock camshaft. On engines which have stud mounted rocker arms be sure and check the rocker arm slot that allows the rocker to pivot at maximum lift. Be sure that there is some slight amount (.060") of additional travel left in this slot when the valve is at maximum lift. Be sure that the rocker arm contacts only the valve tip, and not the valve spring or valve spring retainer.

### Check valve-to-piston clearance

Many times inexperienced or first time camshaft installers forget to check the engine's valve-to-piston clearance and end up by bending some, or all, of the engine's valves when they strike the piston. This is especially critical on an engine with domed pistons, or where the camshaft being installed has more duration and/or maximum valve lift than that of the previous cam. Check this clearance before you fire up the engine. Several ways can be used, the easiest being to use modeling clay placed atop the valve area of a piston and then bolting the cylinder head in place and torquing it to specs. Adjust the valves (don't forget to use the head gasket for

an accurate clearance check) then rotate the engine by hand several times. Remove the head(s) and carefully peel off the clay and measure it with a micrometer. Allow a minimum clearance of .080" intake and .100" exhaust.

### **Bent pushrods means mechanical interference**

If you bend one, two or several pushrods for no apparent reason, then you are experiencing some form of definite mechanical interference in the engine's valve train. Check for rocker arm to stud interference. Valve spring coil binding, interference between the retainer and the valve seal or retainer and valve guide. Also, high RPM might be showing valve-to-piston clearance problems that are causing your valves to strike the pistons and then bending the pushrods. If this occurs, and you suspect valve-to-piston clearance problems, it's a good idea to also check for bent, or leaking valves, and possible piston damage.

### **Never advance or retard your cam timing without first taking the time to "degree in" the camshaft in the engine**

A cam change that doesn't seem to have enough low end power might be an indication. Frequently, retarded cam timing is due to factory retarded timing gears. Always degree-in the cam before you make any timing changes.

### **Always install new lifters on a new (or used) cam**

Never install used (even for just a couple of running minutes) lifters on a new camshaft. The only situation where you can install used lifters on a camshaft, is if the lifters came from the camshaft and are to be replaced onto the same lobe that they were originally run on the cam and in the same engine block.

### **Be sure and properly lube the cam**

Many cams are ruined in the first couple of minutes of their life when they are installed dry or improperly lubricated. Be sure and follow the instructions included with the camshaft or correct pre-lubrication of the cam and lifters before you fire up the engine.

### **Follow cam break-in instructions - especially with regards to oil and filter replacement**

Dirty oil and clogged, old oil filters mean abrasives in the oiling system and wear for the camshaft, lifters and all other engine components as well! Spend a couple of extra dollars and buy high quality oil, and filters, and above all, change both frequently. This will add life to not only cam and lifters, but the entire engine assembly as well.

### **Breaking rocker arm pushrod seats**

We have found this to be a somewhat common problem, especially when an engine has several thousand miles of usage on the rockers. This usually occurs when a cam is installed that has a higher lift than the cam previously used. The additional amount of travel required of the rocker arm tends to relocate the load generated by the valve train and concentrates it partially in the already worn area of the rocker arm pushrod seat and partially in the area not yet worn. The result is a concentration of this loading in an area of thinner metal, and breaking through or punching out of the pushrod seat often occurs. The cure is to install new stock-type steel rocker arms, or a set of Crane aluminum rockers.

### **We do not recommend the use of synthetic oils during break-in**

While considerable progress has been made in developing synthetic motor oils, we do not recommend their use during break-in of regular flat faced hydraulic or mechanical (non-roller) lifter style camshafts. Instead, use a quality grade of naturally formulated, non-synthetic motor oil during this period. Most major synthetic oil manufacturers agree with this procedure. If you choose to use synthetic oil after the break-in period, follow the manufacturer's instructions to ensure proper lubrication.

## **LIMITED WARRANTY**

Crane Cams, Incorporated warrants that all of its products are free from defects in material and workmanship. All Crane Cams performance products are subject to the conditions established in this policy.

Crane Cams, Incorporated warrants that when our products are properly installed in their correct application, they will be free from defect and will function as specified.

Due to the variety of modifications made on performance engines that may affect performance, economy and engine life, Crane Cams' obligation under this warranty is limited to the repair or replacement, only of Crane products, when the consumer returns these Crane Cams products directly to Crane Cams, Incorporated, Warranty Department, 530 Fentress Blvd., Daytona Beach, FL 32114.

There is absolutely no warranty, implied or otherwise, on Crane Cams parts used in competition (racing) engine applications.

This limited warranty begins on the date of purchase and is good for a period of one year from validated date of purchase unless otherwise specified to the original purchaser.

This warranty will be void on all products that show evidence of misapplication, improper installation, abuse, lack of proper maintenance, negligence, racing engine use, or alteration from their original design.

Crane Cams, Incorporated reserves the right to make necessary changes in the products it manufactures and markets at any time to improve product performance. These changes in products will be made without obligation to change or improve products that were previously manufactured.

This warranty limits any implied warranty to one year, and no person, company or organization is authorized to assume for Crane Cams, Incorporated any other liability in connection with the sale of Crane Cams products. Some states do not allow limitations on how long an implied warranty lasts.

This limited warranty gives you specific legal rights, and you may also have other rights, which vary, from state to state.